

User Manual

# SOM-5892

**ADVANTECH**

*Enabling an Intelligent Planet*

---

## Copyright

The documentation and the software included with this product are copyrighted 2012 by Advantech Co., Ltd. All rights are reserved. Advantech Co., Ltd. reserves the right to make improvements in the products described in this manual at any time without notice. No part of this manual may be reproduced, copied, translated or transmitted in any form or by any means without the prior written permission of Advantech Co., Ltd. Information provided in this manual is intended to be accurate and reliable. However, Advantech Co., Ltd. assumes no responsibility for its use, nor for any infringements of the rights of third parties, which may result from its use.

## Acknowledgements

Intel and Pentium are trademarks of Intel Corporation.

Microsoft Windows and MS-DOS are registered trademarks of Microsoft Corp.

All other product names or trademarks are properties of their respective owners.

## Product Warranty (2 years)

Advantech warrants to you, the original purchaser, that each of its products will be free from defects in materials and workmanship for two years from the date of purchase.

This warranty does not apply to any products which have been repaired or altered by persons other than repair personnel authorized by Advantech, or which have been subject to misuse, abuse, accident or improper installation. Advantech assumes no liability under the terms of this warranty as a consequence of such events.

Because of Advantech's high quality-control standards and rigorous testing, most of our customers never need to use our repair service. If an Advantech product is defective, it will be repaired or replaced at no charge during the warranty period. For out-of-warranty repairs, you will be billed according to the cost of replacement materials, service time and freight. Please consult your dealer for more details.

If you think you have a defective product, follow these steps:

1. Collect all the information about the problem encountered. (For example, CPU speed, Advantech products used, other hardware and software used, etc.) Note anything abnormal and list any onscreen messages you get when the problem occurs.
2. Call your dealer and describe the problem. Please have your manual, product, and any helpful information readily available.
3. If your product is diagnosed as defective, obtain an RMA (return merchandise authorization) number from your dealer. This allows us to process your return more quickly.
4. Carefully pack the defective product, a fully-completed Repair and Replacement Order Card and a photocopy proof of purchase date (such as your sales receipt) in a shippable container. A product returned without proof of the purchase date is not eligible for warranty service.
5. Write the RMA number visibly on the outside of the package and ship it prepaid to your dealer.

# Declaration of Conformity

## CE

This product has passed the CE test for environmental specifications. Test conditions for passing included the equipment being operated within an industrial enclosure. In order to protect the product from being damaged by ESD (Electrostatic Discharge) and EMI leakage, we strongly recommend the use of CE-compliant industrial enclosure products.

## FCC Class B

Note: This equipment has been tested and found to comply with the limits for a Class B digital device, pursuant to part 15 of the FCC Rules. These limits are designed to provide reasonable protection against harmful interference in a residential installation. This equipment generates, uses and can radiate radio frequency energy and, if not installed and used in accordance with the instructions, may cause harmful interference to radio communications. However, there is no guarantee that interference will not occur in a particular installation. If this equipment does cause harmful interference to radio or television reception, which can be determined by turning the equipment off and on, the user is encouraged to try to correct the interference by one or more of the following measures:

- Reorient or relocate the receiving antenna.
- Increase the separation between the equipment and receiver.
- Connect the equipment into an outlet on a circuit different from that to which the receiver is connected.
- Consult the dealer or an experienced radio/TV technician for help.

## FM

This equipment has passed the FM certification. According to the National Fire Protection Association, work sites are classified into different classes, divisions and groups, based on hazard considerations. This equipment is compliant with the specifications of Class I, Division 2, Groups A, B, C and D indoor hazards.

# Technical Support and Assistance

1. Visit the Advantech website at <http://support.advantech.com> where you can find the latest information about the product.
2. Contact your distributor, sales representative, or Advantech's customer service center for technical support if you need additional assistance. Please have the following information ready before you call:
  - Product name and serial number
  - Description of your peripheral attachments
  - Description of your software (operating system, version, application software, etc.)
  - A complete description of the problem
  - The exact wording of any error messages

---

## Warnings, Cautions and Notes

**Warning!** Warnings indicate conditions, which if not observed, can cause personal injury!



**Caution!** Cautions are included to help you avoid damaging hardware or losing data. e.g.



*There is a danger of a new battery exploding if it is incorrectly installed. Do not attempt to recharge, force open, or heat the battery. Replace the battery only with the same or equivalent type recommended by the manufacturer. Discard used batteries according to the manufacturer's instructions.*

**Note!** Notes provide optional additional information.



## Document Feedback

To assist us in making improvements to this manual, we would welcome comments and constructive criticism. Please send all such - in writing to: [support@advantech.com](mailto:support@advantech.com)

## Packing List

Before setting up the system, check that the items listed below are included and in good condition. If any item does not accord with the table, please contact your dealer immediately.

- SOM-5892 CPU Module
- 1 x Heatspreader (1960055344N001)

# Safety Instructions

1. Read these safety instructions carefully.
2. Keep this User Manual for later reference.
3. Disconnect this equipment from any AC outlet before cleaning. Use a damp cloth. Do not use liquid or spray detergents for cleaning.
4. For plug-in equipment, the power outlet socket must be located near the equipment and must be easily accessible.
5. Keep this equipment away from humidity.
6. Put this equipment on a reliable surface during installation. Dropping it or letting it fall may cause damage.
7. The openings on the enclosure are for air convection. Protect the equipment from overheating. **DO NOT COVER THE OPENINGS.**
8. Make sure the voltage of the power source is correct before connecting the equipment to the power outlet.
9. Position the power cord so that people cannot step on it. Do not place anything over the power cord.
10. All cautions and warnings on the equipment should be noted.
11. If the equipment is not used for a long time, disconnect it from the power source to avoid damage by transient overvoltage.
12. Never pour any liquid into an opening. This may cause fire or electrical shock.
13. Never open the equipment. For safety reasons, the equipment should be opened only by qualified service personnel.
14. If one of the following situations arises, get the equipment checked by service personnel:
  - The power cord or plug is damaged.
  - Liquid has penetrated into the equipment.
  - The equipment has been exposed to moisture.
  - The equipment does not work well, or you cannot get it to work according to the user's manual.
  - The equipment has been dropped and damaged.
  - The equipment has obvious signs of breakage.
15. **DO NOT LEAVE THIS EQUIPMENT IN AN ENVIRONMENT WHERE THE STORAGE TEMPERATURE MAY GO BELOW -20° C (-4° F) OR ABOVE 60° C (140° F). THIS COULD DAMAGE THE EQUIPMENT. THE EQUIPMENT SHOULD BE IN A CONTROLLED ENVIRONMENT.**
16. **CAUTION: DANGER OF EXPLOSION IF BATTERY IS INCORRECTLY REPLACED. REPLACE ONLY WITH THE SAME OR EQUIVALENT TYPE RECOMMENDED BY THE MANUFACTURER, DISCARD USED BATTERIES ACCORDING TO THE MANUFACTURER'S INSTRUCTIONS.**

The sound pressure level at the operator's position according to IEC 704-1:1982 is no more than 70 dB (A).

**DISCLAIMER:** This set of instructions is given according to IEC 704-1. Advantech disclaims all responsibility for the accuracy of any statements contained herein.

---

## Safety Precaution - Static Electricity

Follow these simple precautions to protect yourself from harm and the products from damage.

- To avoid electrical shock, always disconnect the power from your PC chassis before you work on it. Don't touch any components on the CPU card or other cards while the PC is on.
- Disconnect power before making any configuration changes. The sudden rush of power as you connect a jumper or install a card may damage sensitive electronic components.

# Contents

<b>Chapter 1</b>	<b>General Information .....</b>	<b>1</b>
1.1	Introduction .....	2
1.2	Specifications .....	2
1.2.1	Board Information .....	2
1.2.2	System Information .....	2
1.2.3	Display .....	3
1.2.4	Expansion Interface .....	3
1.2.5	I/O .....	4
1.2.6	iManager 2.0 .....	4
1.2.7	Mechanical and Environmental Specification .....	4
1.3	Functional Block Diagram .....	5
1.4	SOM-5892 Type 6 Pin Assignment .....	6
<b>Chapter 2</b>	<b>Mechanical Information .....</b>	<b>11</b>
2.1	Board Information.....	12
	Figure 2.1 Board chips identify - Front.....	12
	Figure 2.2 Board chips identify - Back .....	12
2.2	Mechanical Drawing.....	13
	Figure 2.3 Board Mechanical Drawing - Front .....	13
	Figure 2.4 Board Mechanical Drawing - Back .....	13
<b>Chapter 3</b>	<b>AMI BIOS .....</b>	<b>15</b>
3.1	Introduction .....	16
	Figure 3.1 Setup program initial screen .....	16
3.2	Entering Setup .....	17
3.2.1	Main Setup.....	17
	Figure 3.2 Main setup screen .....	17
3.2.2	Advanced BIOS Features Setup.....	18
	Figure 3.3 Advanced BIOS features setup screen .....	18
	Figure 3.4 Advantech BIOS Update V1.3 .....	19
	Figure 3.5 ACPI Settings .....	20
	Figure 3.6 Trusted Computing .....	21
	Figure 3.7 CPU Configuration.....	22
	Figure 3.8 SATA Configuration.....	23
	Figure 3.9 Intel® Rapid Technology .....	24
	Figure 3.10 Intel TXT(LT) Configuration .....	25
	Figure 3.11 PCH-FW Configuration.....	26
	Figure 3.12 Firmware Update Configuration.....	27
	Figure 3.13 Intel® Anti-Theft Technology Configuration.....	28
	Figure 3.14 AMT Configuration.....	29
	Figure 3.15 USB Configuration .....	30
	Figure 3.16 SMART Settings .....	31
	Figure 3.17 Embedded Controller Configuration .....	32
	Figure 3.18 Intel® Smart Connect Technology.....	33
	Figure 3.19 Super IO Configuration .....	34
	Figure 3.20 Serial Port 0 Configuration .....	35
	Figure 3.21 Serial Port 1 Configuration .....	36
	Figure 3.22 Parallel Port Configuration.....	37
	Figure 3.23 Serial Port Console Redirection .....	38
	Figure 3.24 Console Redirection Settings .....	39
	Figure 3.25 CPU PPM Configuration.....	40

	Figure 3.26 Switchable Graphics.....	41
	Figure 3.27 Sandybridge DTS Configuration.....	42
3.2.3	Chipset.....	43
	Figure 3.28 Chipset Setup.....	43
	Figure 3.29 PCH-IO Configuration .....	44
	Figure 3.30 PCI Express Configuration .....	45
	Figure 3.31 PCI Express Root Port 1 .....	46
	Figure 3.32 PCI Express Root Port 2 .....	47
	Figure 3.33 PCI Express Root Port 3 .....	48
	Figure 3.34 PCI Express Root Port 4 .....	49
	Figure 3.35 PCI Express Root Port 5 .....	50
	Figure 3.36 PCI Express Root Port 7 .....	51
	Figure 3.37 PCI Express Root Port 8 .....	52
	Figure 3.38 USB Configuration.....	53
	Figure 3.39 PCH Azalia Configuration.....	54
	Figure 3.40 System Agent (SA) Configuration .....	55
	Figure 3.41 Intel IGFX Configuration.....	56
	Figure 3.42 LCD Control.....	57
	Figure 3.43 NB PCIe Configuration .....	58
	Figure 3.44 PEG Gen3 Root Port Preset Value for each Lane ...	59
	Figure 3.45 PEG Gen3 Endpoint Preset Value each Lane .....	60
	Figure 3.46 PEG Gen3 Endpoint Hint Value each Lane .....	61
3.2.4	Boot Settings .....	62
	Figure 3.47 Boot Setup Utility.....	62
3.2.5	Security Setup .....	63
	Figure 3.48 Password Configuration .....	63
3.2.6	Save & Exit .....	64
	Figure 3.49 Save & Exit.....	64

## **Chapter 4 S/W Introduction & Installation..... 67**

4.1	S/W Introduction .....	68
4.2	Driver Installation .....	68
	4.2.1 Windows XP / Windows 7 Driver Setup.....	68
	4.2.2 Other OS.....	68
4.3	Advantech iManager .....	69

## **Appendix A Watchdog Timer ..... 71**

A.1	Programming the Watchdog Timer .....	72
-----	--------------------------------------	----

## **Appendix B Programming GPIO..... 73**

B.1	GPIO Register.....	74
-----	--------------------	----

## **Appendix C System Assignments..... 75**

C.1	System I/O Ports.....	76
	Table C.1: System I/O Ports .....	76
C.2	DMA Channel Assignments .....	77
	Table C.2: DMA Channel Assignments .....	77
C.3	Interrupt Assignments .....	78
	Table C.3: Interrupt assignments.....	78
C.4	1st MB Memory Map.....	78
	Table C.4: 1st MB memory map .....	78



# Chapter 1

## General Information

This chapter gives background information on the SOM-5892 CPU System on Module.

Sections include:

- Introduction
- Specification
- Functional Block Diagram
- SOM-5892 Type 6-pin Assignment

## 1.1 Introduction

SOM-5892 is a COM-Express Basic module with pin-out Type 6 that fully complies with the PICMG (PCI Industrial Computer Manufacturers Group) COM.0 R2.0 specification. The CPU module builds Intel 3rd Generation Core i processor Ivy Bridge, PCH QM77, and other peripheral chips to fulfill COM specified functionalities. Intel Ivy Bridge uses 22nm and 3D Tri-gate Transistor technologies that brings 15% performance improvement than previous, and integrates powerful Intel HD Graphic 4000 that supports AVC/H.264, VC-1, and MPEG2 hardware encode/decode/transcode. With Intel PCH QM77, SOM-5892 provides advance interfaces such as PCI Express Gen 3rd, SATA Gen 3rd, and USB3.0. Moreover, it is the first embedded chipset which can support 3 display contents simultaneously.

Advantech iManager 2.0 was invented to satisfy embedded application requirements such as multi-level watchdog timer, voltage and temperature monitoring, thermal protection and mitigation through processor throttling, LCD backlight on/off and brightness control, and embedded storage for customized information. Combined with Advantech SUSI Access, it can remotely monitor and control devices via the Internet for efficient maintenance. All Advantech COM Express modules come with iManager and SUSI Access.

SOM-5892 is suitable for computing intensive, thermal sensitive, graphics/media insensitive, and I/O demanding applications.

## 1.2 Specifications

### 1.2.1 Board Information

- **Pin Definition:** PICMG COM.0 R2.0 Type 6 pin-out definition
- **Form Factor:** PICMG COM.0 R2.0 Basic Module 125 x 95 mm

### 1.2.2 System Information

- **CPU:** 3rd Generation Intel® Core Processor

CPU		Core	Cache (MB)	TDP (W)
i7-3615QE	2.3 GHz	4	6	45
i7-3612QE	2.1 GHz	4	6	35
i7-3555LE	2.5 GHz	2	4	25
i7-3517UE	1.7 GHz	2	4	17
i5-3610ME	2.7 GHz	2	3	35
i3-3120ME	2.4 GHz	2	3	35
i3-3217UE	1.6 GHz	2	3	17

- **Chipset:** Intel® QM77 Express Chipset
- **Memory:** 2 SODIMM Socket for DDR3-1600 or DDR3L-1333, up to 16GB
- **BIOS:** AMI UEFI 64Mbit SPI BIOS
- **Power management:** Supports power saving modes including Normal / Standby / Suspend modes. ACPI 2.0 compliant

### 1.2.3 Display

- Graphic Core: Intel® HD Graphic 4000 supports DX11, OGL3.1, OCL1.1, and MPEG2, AVC/H.264, VC-1 HW decode/encode/transcode acceleration

CPU	Graphics Core	Base Freq.	Max Freq.
i7-3615QE	HD Graphics 4000	650 MHz	1000 MHz
i7-3612QE	HD Graphics 4000	650 MHz	1000 MHz
i7-3555LE	HD Graphics 4000	550 MHz	1000 MHz
i7-3517UE	HD Graphics 4000	350 MHz	1000 MHz
i5-3610ME	HD Graphics 4000	650 MHz	950 MHz
i3-3120ME	HD Graphics 4000	650 MHz	900 MHz
i3-3217UE	HD Graphics 4000	350 MHz	900 MHz

- **VGA:** Resolution up to 2048 x 1536
- **LVDS:** Supports single/dual channel 18/24-bit, resolution up to 1920 x 1200 @ 60 Hz
- **HDMI/DVI/DP:** Supports 3 ports HDMI (default), DVI, or DP multiplexed (BIOS modification needed).
- **Resolution:** HDMI/DVI up to 1920 x 1200 @ 60 Hz  
DP up to 2560 x 1600 @ 60 Hz
- **Dual Display:** VGA + LVDS, VGA + HDMI/DVI/DP, LVDS + HDMI/DVI/DP, HDMI/DVI/DP + HDMI/DVI/DP
- **Triple Display:** LVDS + DP + DP

### 1.2.4 Expansion Interface

- **PCI Express x16:** Supports default 1 port PCIe x16 compliant to PCIe Gen2\* (5.0 GT/s) specification, several configurable combinations may need BOM reworks. Please contact Advantech sales or FAE for more details.

	x16	x8	x4
Default	1	0	0
Option 1	0	2	0
Option 2	0	1	2

- **PCI Express x1:** Supports default 7 ports PCIe x1 compliant to PCIe Gen2\* (5.0 GT/s) specification, several configurable combinations may need BIOS modification. Please contact Advantech sales or FAE for more details.

	x4	x2	x1
Default	0	0	7
Option 1	0	2	3
Option 2	1	0	3

- **Audio Interface:** Intel HD Audio interface
- **LPC Bus**
- **SMBus**
- **I2C Bus:** Up to 400 KHz
- **SPI:** Supports SPI BIOS only

---

## 1.2.5 I/O

- **Ethernet:** Intel 82579LM Gigabit LAN supports 10/100/1000 Mbps Speed
- **SATA:** Supports 2 ports SATA Gen3 (600 Gb/s), 2 ports SATA Gen2 (300 Gb/s)
- **USB Interface:** Supports 4 USB 3.0 ports, 8 USB 2.0 ports
- **Serial Port:** Supports 2 x 2-wire serial ports
- **Express Card:** 2 ports
- **Panel Control:** Supports panel backlight on/off control, brightness control
- **Thermal Protection:** Supports thermal shutdown or CPU throttling
- **Watchdog Timer:** 65536 level timer interval, from 0~65535 sec, multi-level, multi-option watchdog timer
- **Smart Fan:** 1 port on Module, 1 port down to carrier board
- **GPIO:** 8 GPIO
- **Hardware Monitor:** Vin, 5VSB, CMOS
- **TPM:** BOM option, default not support

## 1.2.6 iManager 2.0

Refer to section 4.3

## 1.2.7 Mechanical and Environmental Specification

- **Dimensions:** 125 x 95 mm (4.92" x 3.74")
- **Power Type and Supply Voltage:**
  - ATX: +12 V and +5 VSB (standby power)
  - AT: +12 V
  - CMOS Battery: +3.3 V
- **Power Requirement:**
  - **Test condition:** SOM-5892FG-U1A1E (i7-3612QE), DDR3-1333 4GB, WIN7 32-bit, under 12 V and 5VSB input power supply.
  - **Idle:** 6.6 W
  - **Max:** 36 W (Burn-in V6.0 Pro)
- **Temperature Specification:**
  - **Operating:** 0 ~ 60° C (32 ~ 140 ° F)
  - **Storage:** -40 ~ 85° C (-40 ~ 185° F)
- **Humidity Specification:**
  - Operating: 40° C @ 95% relative humidity, non-condensing
  - Storage: 60° C @ 95% relative humidity, non-condensing

### 1.3 Functional Block Diagram

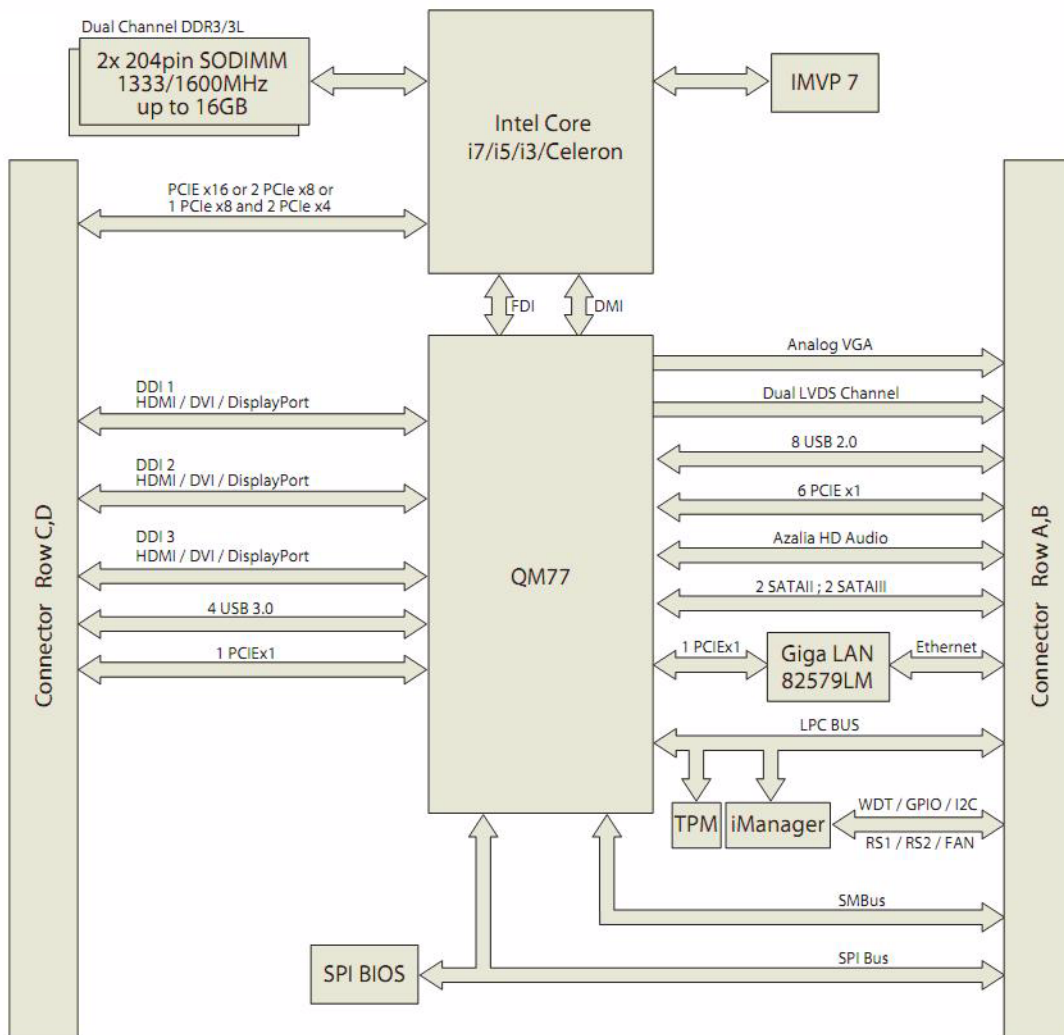

## 1.4 SOM-5892 Type 6 Pin Assignment

This section gives SOM-5892 pin assignment on COM Express connector which compliant with COMR.0 R2.0 Type 6 pin-out definitions. More details about how to use these pins and get design references, please contact to Advantech for design guide, checklist, reference schematic, and other hardware/software support.

SOM-5892 Row A, B			
A1	GND	B1	GND
A2	GBE0_MDI3-	B2	GBE0_ACT#
A3	GBE0_MDI3+	B3	LPC_FRAME#
A4	GBE0_LINK100#	B4	LPC_AD0
A5	GBE0_LINK1000#	B5	LPC_AD1
A6	GBE0_MDI2-	B6	LPC_AD2
A7	GBE0_MDI2+	B7	LPC_AD3
A8	GBE0_LINK#	B8	LPC_DRQ0#
A9	GBE0_MDI1-	B9	LPC_DRQ1#
A10	GBE0_MDI1+	B10	LPC_CLK
A11	GND	B11	GND
A12	GBE0_MDI0-	B12	PWRBTN#
A13	GBE0_MDI0+	B13	SMB_CK
A14	N/A	B14	SMB_DAT
A15	SUS_S3#	B15	SMB_ALERT#
A16	SATA0_TX+	B16	SATA1_TX+
A17	SATA0_TX-	B17	SATA1_TX-
A18	SUS_S4#	B18	SUS_STAT#
A19	SATA0_RX+	B19	SATA1_RX+
A20	SATA0_RX-	B20	SATA1_RX-
A21	GND	B21	GND
A22	SATA2_TX+	B22	SATA3_TX+
A23	SATA2_TX-	B23	SATA3_TX-
A24	SUS_S5#	B24	PWR_OK
A25	SATA2_RX+	B25	SATA3_RX+
A26	SATA2_RX-	B26	SATA3_RX-
A27	BATLOW#	B27	WDT
A28	SATA_ACT#	B28	HDA_SDIN2
A29	HDA_SYNC	B29	HDA_SDIN1
A30	HDA_RST#	B30	HDA_SDIN0
A31	GND	B31	GND
A32	HDA_BITCLK	B32	SPKR
A33	HDA_SDOOUT	B33	I2C_CK
A34	BIOS_DIS0#	B34	I2C_DAT
A35	THRMTRIP#	B35	THRM#
A36	USB6-	B36	USB7-
A37	USB6+	B37	USB7+
A38	USB_6_7_OC#	B38	USB_4_5_OC#
A39	USB4-	B39	USB5-
A40	USB4+	B40	USB5+

A41	GND	B41	GND
A42	USB2-	B42	USB3-
A43	USB2+	B43	USB3+
A44	USB_2_3_OC#	B44	USB_0_1_OC#
A45	USB0-	B45	USB1-
A46	USB0+	B46	USB1+
A47	VCC_RTC	B47	EXCD1_PERST#
A48	EXCD0_PERST#	B48	EXCD1_CPPE#
A49	EXCD0_CPPE#	B49	SYS_RESET#
A50	LPC_SERIRQ	B50	CB_RESET#
A51	GND	B51	GND
A52	PCIE_TX5+	B52	PCIE_RX5+
A53	PCIE_TX5-	B53	PCIE_RX5-
A54	GPI0	B54	GPO1
A55	PCIE_TX4+	B55	PCIE_RX4+
A56	PCIE_TX4-	B56	PCIE_RX4-
A57	GND	B57	GPO2
A58	PCIE_TX3+	B58	PCIE_RX3+
A59	PCIE_TX3-	B59	PCIE_RX3-
A60	GND	B60	GND
A61	PCIE_TX2+	B61	PCIE_RX2+
A62	PCIE_TX2-	B62	PCIE_RX2-
A63	GPI1	B63	GPO3
A64	PCIE_TX1+	B64	PCIE_RX1+
A65	PCIE_TX1-	B65	PCIE_RX1-
A66	GND	B66	WAKE0#
A67	GPI2	B67	WAKE1#
A68	PCIE_TX0+	B68	PCIE_RX0+
A69	PCIE_TX0-	B69	PCIE_RX0-
A70	GND	B70	GND
A71	LVDS_A0+	B71	LVDS_B0+
A72	LVDS_A0-	B72	LVDS_B0-
A73	LVDS_A1+	B73	LVDS_B1+
A74	LVDS_A1-	B74	LVDS_B1-
A75	LVDS_A2+	B75	LVDS_B2+
A76	LVDS_A2-	B76	LVDS_B2-
A77	LVDS_VDD_EN	B77	LVDS_B3+
A78	LVDS_A3+	B78	LVDS_B3-
A79	LVDS_A3-	B79	LVDS_BKLT_EN
A80	GND	B80	GND
A81	LVDS_A_CK+	B81	LVDS_B_CK+
A82	LVDS_A_CK-	B82	LVDS_B_CK-
A83	LVDS_I2C_CK	B83	LVDS_BKLT_CTRL
A84	LVDS_I2C_DAT	B84	VCC_5V_SBY
A85	GPI3	B85	VCC_5V_SBY
A86	RSVD	B86	VCC_5V_SBY
A87	RSVD	B87	VCC_5V_SBY
A88	PCIE0_CK_REF+	B88	BIOS_DIS1#

A89	PCIE0_CK_REF-	B89	VGA_RED
A90	GND	B90	GND
A91	SPI_POWER	B91	VGA_GRN
A92	SPI_MISO	B92	VGA_BLU
A93	GPO0	B93	VGA_HSYNC
A94	SPI_CLK	B94	VGA_VSYNC
A95	SPI_MOSI	B95	VGA_I2C_CK
A96	PP_TPM	B96	VGA_I2C_DAT
A97	TYPE10#	B97	SPI_CS#
A98	RS1_TX	B98	RSVD
A99	RS1_RX	B99	RSVD
A100	GND	B100	GND
A101	RS2_TX	B101	FAN_PWMOUT
A102	RS2_RX	B102	FAN_TACHIN
A103	LID#	B103	SLEEP#
A104	VCC_12V	B104	VCC_12V
A105	VCC_12V	B105	VCC_12V
A106	VCC_12V	B106	VCC_12V
A107	VCC_12V	B107	VCC_12V
A108	VCC_12V	B108	VCC_12V
A109	VCC_12V	B109	VCC_12V
A110	GND	B110	GND

**SOM-5892 Row C, D**

C1	GND	D1	GND
C2	GND	D2	GND
C3	USB_SSRX0-	D3	USB_SSTX0-
C4	USB_SSRX0+	D4	USB_SSTX0+
C5	GND	D5	GND
C6	USB_SSRX1-	D6	USB_SSTX1-
C7	USB_SSRX1+	D7	USB_SSTX1+
C8	GND	D8	GND
C9	USB_SSRX2-	D9	USB_SSTX2-
C10	USB_SSRX2+	D10	USB_SSTX2+
C11	GND	D11	GND
C12	USB_SSRX3-	D12	USB_SSTX3-
C13	USB_SSRX3+	D13	USB_SSTX3+
C14	GND	D14	GND
C15	DDI1_PAIR6+	D15	DDI1_AUX+
C16	DDI1_PAIR6-	D16	DDI1_AUX-
C17	RSVD	D17	RSVD
C18	RSVD	D18	RSVD
C19	PCIE_RX6+	D19	PCIE_TX6+
C20	PCIE_RX6-	D20	PCIE_TX6-
C21	GND	D21	GND
C22	N/A	D22	N/A
C23	N/A	D23	N/A
C24	DDI1_HPD	D24	RSVD



C25	DDI1_PAIR4+	D25	RSVD
C26	DDI1_PAIR4-	D26	DDI1_PAIR0+
C27	RSVD	D27	DDI1_PAIR0-
C28	RSVD	D28	RSVD
C29	DDI1_PAIR5+	D29	DDI1_PAIR1+
C30	DDI1_PAIR5-	D30	DDI1_PAIR1-
C31	GND	D31	GND
C32	DDI2_AUX+	D32	DDI1_PAIR2+
C33	DDI2_AUX-	D33	DDI1_PAIR2-
C34	DDI2_CTRLCLK	D34	DDI2_CTRLDATA
C35	RSVD	D35	RSVD
C36	DDI3_AUX+	D36	DDI1_PAIR3+
C37	DDI3_AUX-	D37	DDI1_PAIR3-
C38	DDI3_CTRLCLK	D38	DDI3_CTRLDATA
C39	DDI3_PAIR0+	D39	DDI2_PAIR0+
C40	DDI3_PAIR0-	D40	DDI2_PAIR0-
C41	GND	D41	GND
C42	DDI3_PAIR1+	D42	DDI2_PAIR1+
C43	DDI3_PAIR1-	D43	DDI2_PAIR1-
C44	DDI3_HPD	D44	DDI2_HPD
C45	RSVD	D45	RSVD
C46	DDI3_PAIR2+	D46	DDI2_PAIR2+
C47	DDI3_PAIR2-	D47	DDI2_PAIR2-
C48	RSVD	D48	RSVD
C49	DDI3_PAIR3+	D49	DDI2_PAIR3+
C50	DDI3_PAIR3-	D50	DDI2_PAIR3-
C51	GND	D51	GND
C52	PEG_RX0+	D52	PEG_TX0+
C53	PEG_RX0-	D53	PEG_TX0-
C54	TYPE0#	D54	PEG_LANE_RV#
C55	PEG_RX1+	D55	PEG_TX1+
C56	PEG_RX1-	D56	PEG_TX1-
C57	TYPE1#	D57	TYPE2#
C58	PEG_RX2+	D58	PEG_TX2+
C59	PEG_RX2-	D59	PEG_TX2-
C60	GND	D60	GND
C61	PEG_RX3+	D61	PEG_TX3+
C62	PEG_RX3-	D62	PEG_TX3-
C63	RSVD	D63	RSVD
C64	RSVD	D64	RSVD
C65	PEG_RX4+	D65	PEG_TX4+
C66	PEG_RX4-	D66	PEG_TX4-
C67	RSVD	D67	GND
C68	PEG_RX5+	D68	PEG_TX5+
C69	PEG_RX5-	D69	PEG_TX5-
C70	GND	D70	GND
C71	PEG_RX6+	D71	PEG_TX6+
C72	PEG_RX6-	D72	PEG_TX6-

C73	DDI1_CTRLDATA	D73	DDI1_CTRLCLK
C74	PEG_RX7+	D74	PEG_TX7+
C75	PEG_RX7-	D75	PEG_TX7-
C76	GND	D76	GND
C77	RSVD	D77	RSVD
C78	PEG_RX8+	D78	PEG_TX8+
C79	PEG_RX8-	D79	PEG_TX8-
C80	GND	D80	GND
C81	PEG_RX9+	D81	PEG_TX9+
C82	PEG_RX9-	D82	PEG_TX9-
C83	RSVD	D83	RSVD
C84	GND	D84	GND
C85	PEG_RX10+	D85	PEG_TX10+
C86	PEG_RX10-	D86	PEG_TX10-
C87	GND	D87	GND
C88	PEG_RX11+	D88	PEG_TX11+
C89	PEG_RX11-	D89	PEG_TX11-
C90	GND	D90	GND
C91	PEG_RX12+	D91	PEG_TX12+
C92	PEG_RX12-	D92	PEG_TX12-
C93	GND	D93	GND
C94	PEG_RX13+	D94	PEG_TX13+
C95	PEG_RX13-	D95	PEG_TX13-
C96	GND	D96	GND
C97	RSVD	D97	PEG_ENABLE#
C98	PEG_RX14+	D98	PEG_TX14+
C99	PEG_RX14-	D99	PEG_TX14-
C100	GND	D100	GND
C101	PEG_RX15+	D101	PEG_TX15+
C102	PEG_RX15-	D102	PEG_TX15-
C103	GND	D103	GND
C104	VCC_12V	D104	VCC_12V
C105	VCC_12V	D105	VCC_12V
C106	VCC_12V	D106	VCC_12V
C107	VCC_12V	D107	VCC_12V
C108	VCC_12V	D108	VCC_12V
C109	VCC_12V	D109	VCC_12V
C110	GND	D110	GND

# Chapter 2

## Mechanical Information

This chapter gives mechanical and connector information on the SOM-5892 CPU System on Module.

Sections include:

- Board Information
- Mechanical Drawing

## 2.1 Board Information

The figures below indicate the main chips on SOM-5892 Computer-on-Module. Please be aware on these positions while designing customer's own carrier board to avoid mechanical violence and thermal solutions for best thermal dissipation performance.

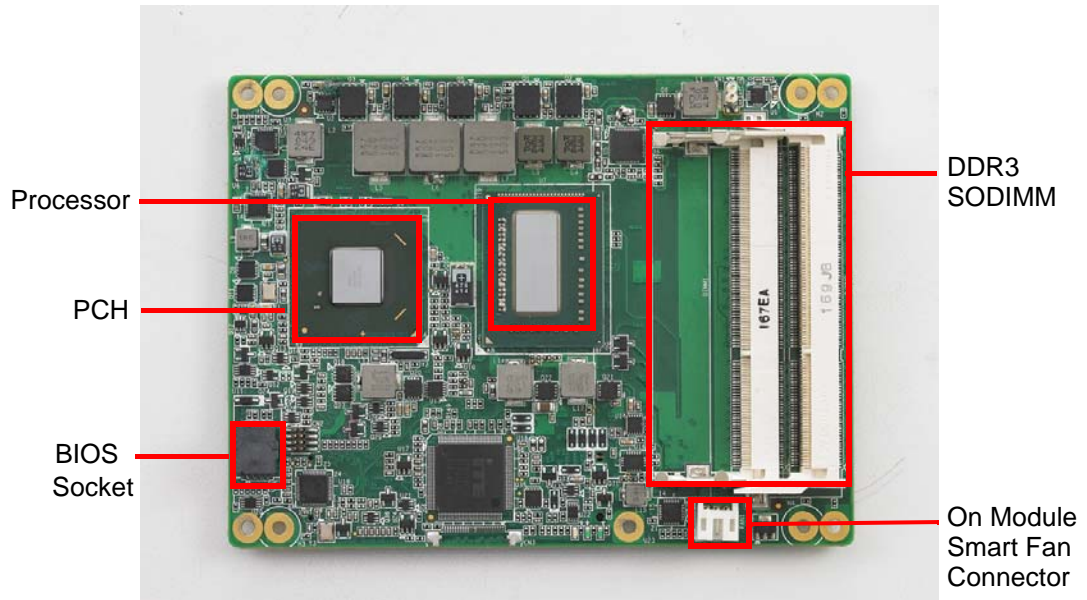

Figure 2.1 Board chips identify - Front

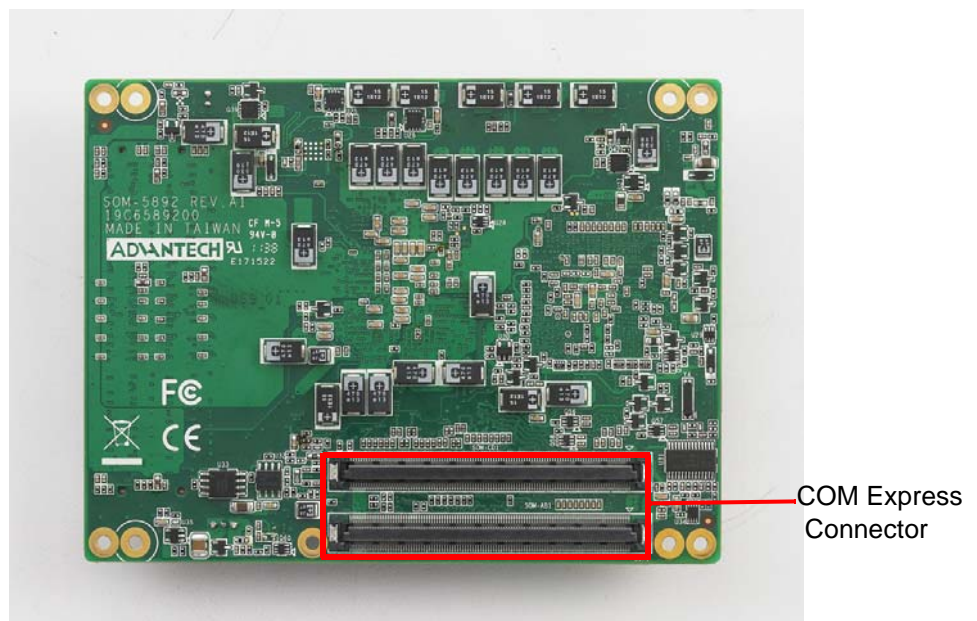
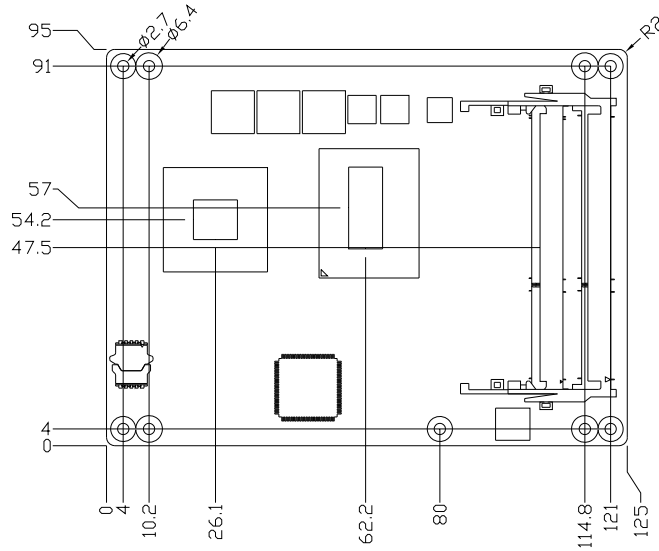

Figure 2.2 Board chips identify - Back

## 2.2 Mechanical Drawing

For more detail about 2D/3D models, please find on Advantech COM support service website <http://com.advantech.com>.



**Figure 2.3 Board Mechanical Drawing - Front**

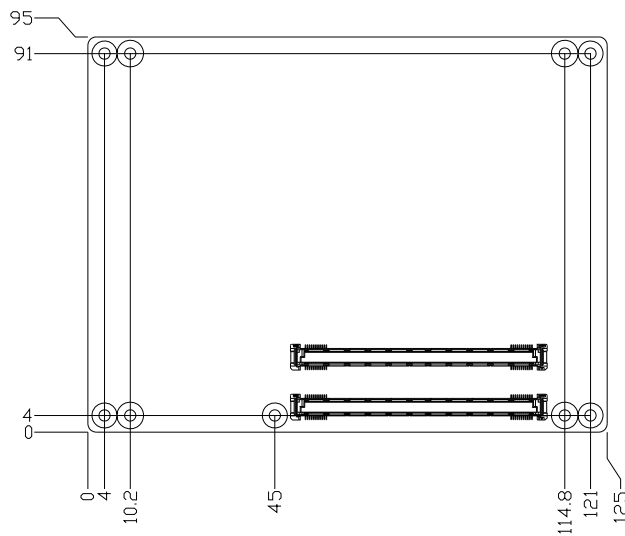

**Figure 2.4 Board Mechanical Drawing - Back**



# Chapter 3

## AMI BIOS

Sections include:

- Introduction
- Entering Setup

## 3.1 Introduction

AMIBIOS has been integrated into many motherboards for over a decade. With the AMIBIOS Setup program, users can modify BIOS settings and control various system features. This chapter describes the basic navigation of the SOM-5892 BIOS setup screens.

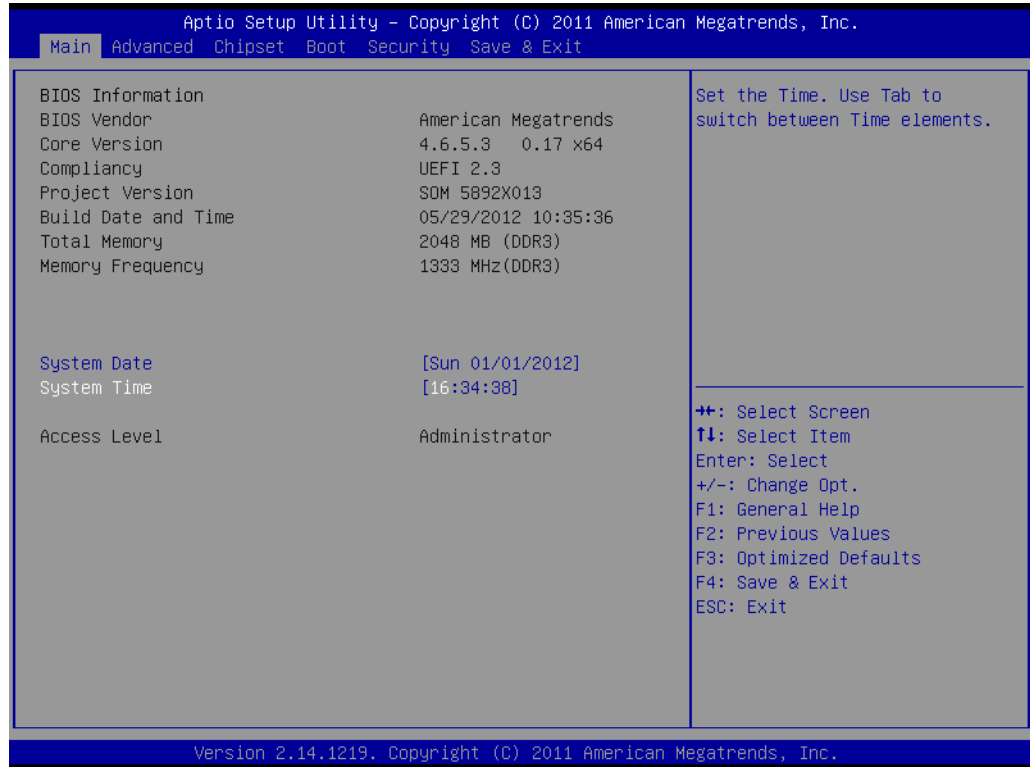

**Figure 3.1 Setup program initial screen**

AMI's BIOS ROM has a built-in Setup program that allows users to modify the basic system configuration. This information is stored in battery-backed CMOS so it retains the Setup information when the power is turned off.



## 3.2 Entering Setup

Turn on the computer and then press <F2> or <DEL> to enter Setup menu.

### 3.2.1 Main Setup

When users first enter the BIOS Setup Utility, users will enter the Main setup screen. Users can always return to the Main setup screen by selecting the Main tab. There are two Main Setup options. They are described in this section. The Main BIOS Setup screen is shown below.

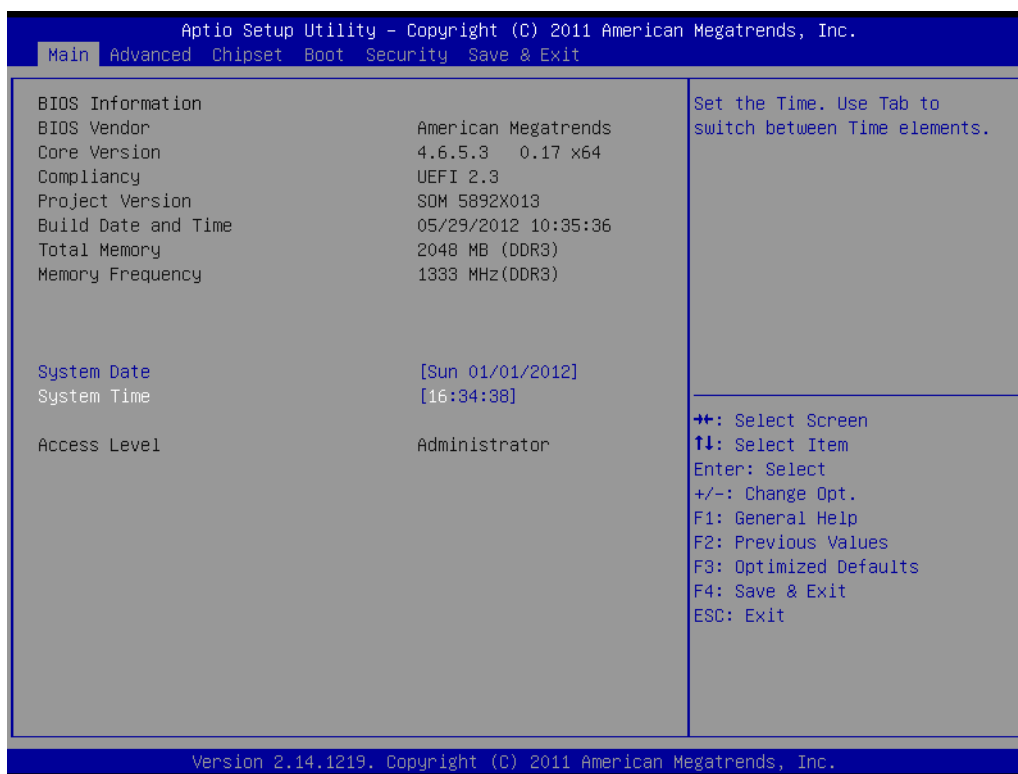

**Figure 3.2 Main setup screen**

The Main BIOS setup screen has two main frames. The left frame displays all the options that can be configured. Grayed-out options cannot be configured; options in blue can. The right frame displays the key legend.

Above the key legend is an area reserved for a text message. When an option is selected in the left frame, it is highlighted in white. Often a text message will accompany it.

#### ■ System time / System date

Use this option to change the system time and date. Highlight System Time or System Date using the <Arrow> keys. Enter new values through the keyboard. Press the <Tab> key or the <Arrow> keys to move between fields. The date must be entered in MM/DD/YY format. The time must be entered in HH:MM:SS format.

### 3.2.2 Advanced BIOS Features Setup

Select the Advanced tab from the SOM-5892 setup screen to enter the Advanced BIOS Setup screen. Users can select any item in the left frame of the screen, such as CPU Configuration, to go to the sub menu for that item. Users can display an Advanced BIOS Setup option by highlighting it using the <Arrow> keys. All Advanced BIOS Setup options are described in this section. The Advanced BIOS Setup screens are shown below. The sub menus are described on the following pages.

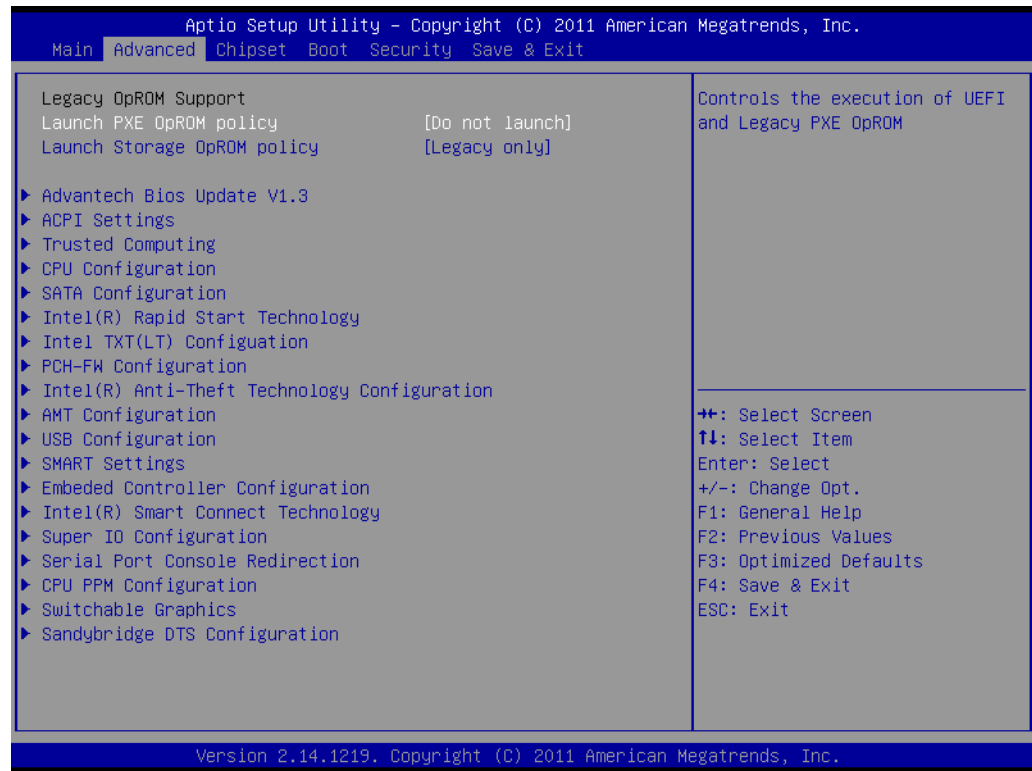
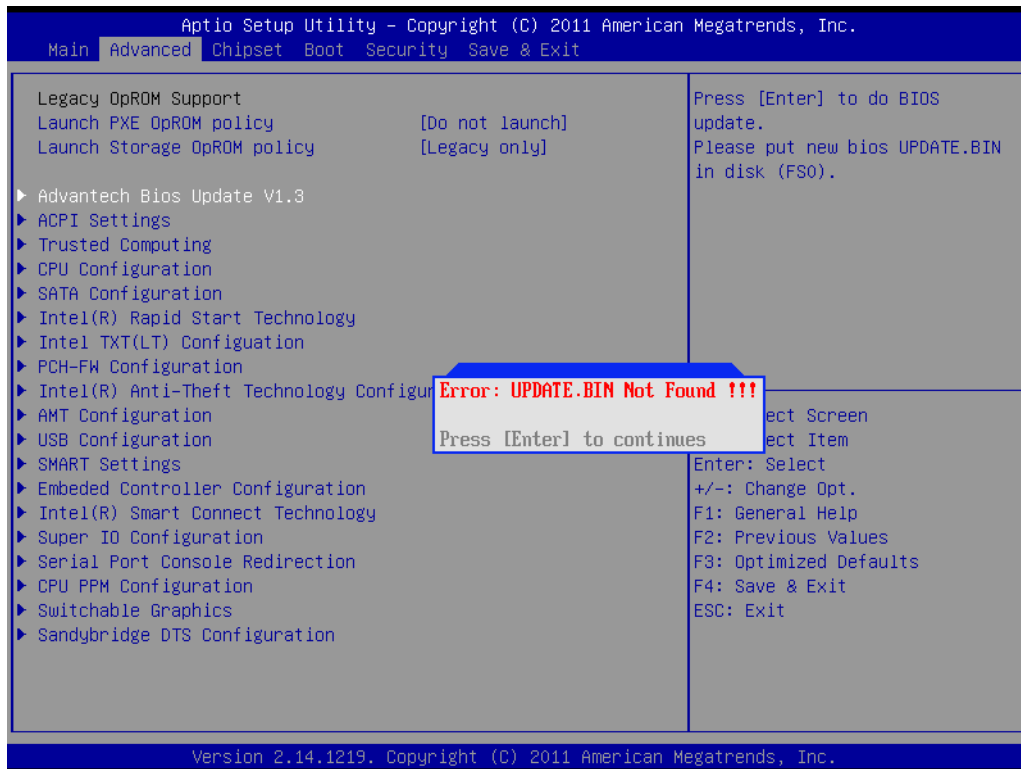

Figure 3.3 Advanced BIOS features setup screen

- **Launch PXE OpROM policy**  
This item allows users to enable or disable launch PXE OpROM if available.
- **Launch Storage OpROM policy**  
This item allows users to enable or disable launch storage OpROM if available.

### 3.2.2.1 Advantech BIOS Update V1.3



**Figure 3.4 Advantech BIOS Update V1.3**

- **Advantech BIOS Update V1.3**  
This item allows users to update BIOS flash ROM.

### 3.2.2.2 ACPI Settings

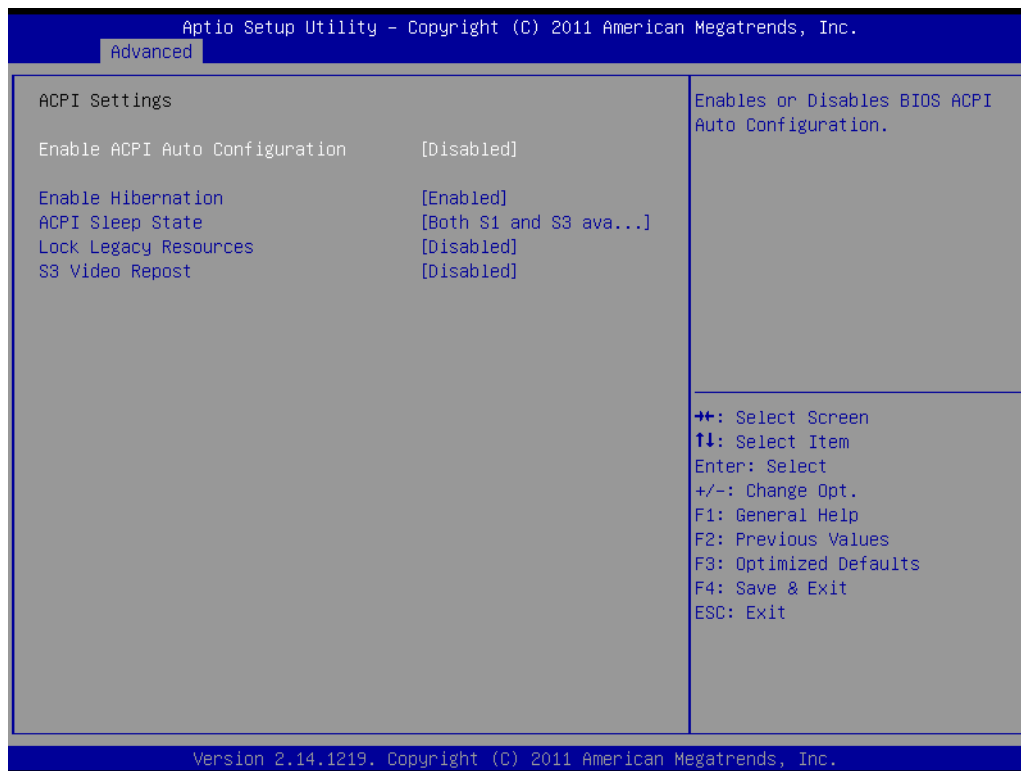
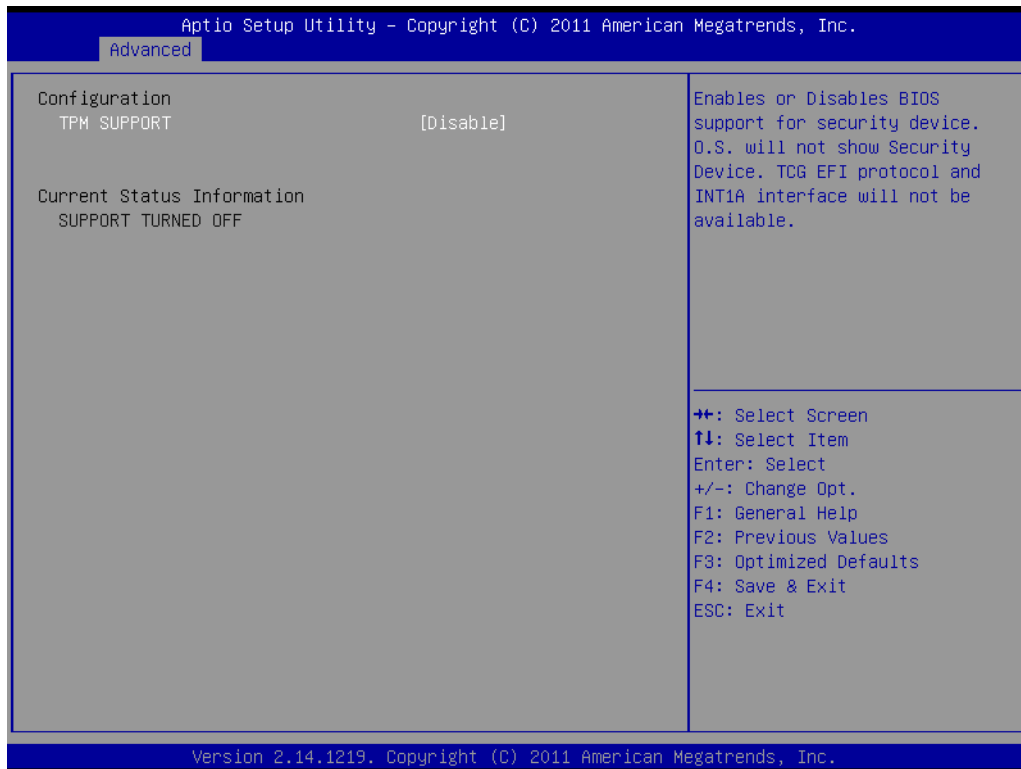

Figure 3.5 ACPI Settings

- **Enable ACPI Auto Configuration**  
This item allows users to enable or disable BIOS ACPI auto configuration.
- **Enable Hibernation**  
This item allows users to enable or disable hibernation.
- **ACPI Sleep State**  
This item allows users to set the ACPI sleep state.
- **Lock Legacy Resources**  
This item allows users to lock legacy devices' resources.
- **S3 Video Repost**  
This item allows users to enable or disable S3 Video Repost.

### 3.2.2.3 Trusted Computing



**Figure 3.6 Trusted Computing**

- **TPM Support**  
 Disable/Enable TPM if available.

### 3.2.2.4 CPU Configuration



Figure 3.7 CPU Configuration

- **Hyper Threading Technology**  
This item allows users to enable or disable Intel Hyper Threading technology.
- **Active Processor Cores**  
This item allows users to set how many processor cores should be active.
- **Limit CPUID Maximum**  
This item allows users to limit the maximum value of CPUID.
- **Execute Disable Bit**  
This item allows users to enable or disable the No-Execution page protection technology.
- **Intel Virtualization Technology**  
This item allows users to enable or disable the intel virtualization technology.
- **Hardware Prefetcher**  
This item allows users to enable or disable the hardware prefetcher feature.
- **Adjacent Cache Line Prefetch**  
This item allows users to enable or disable the adjacent cache line prefetch feature.

### 3.2.2.5 SATA Configuration

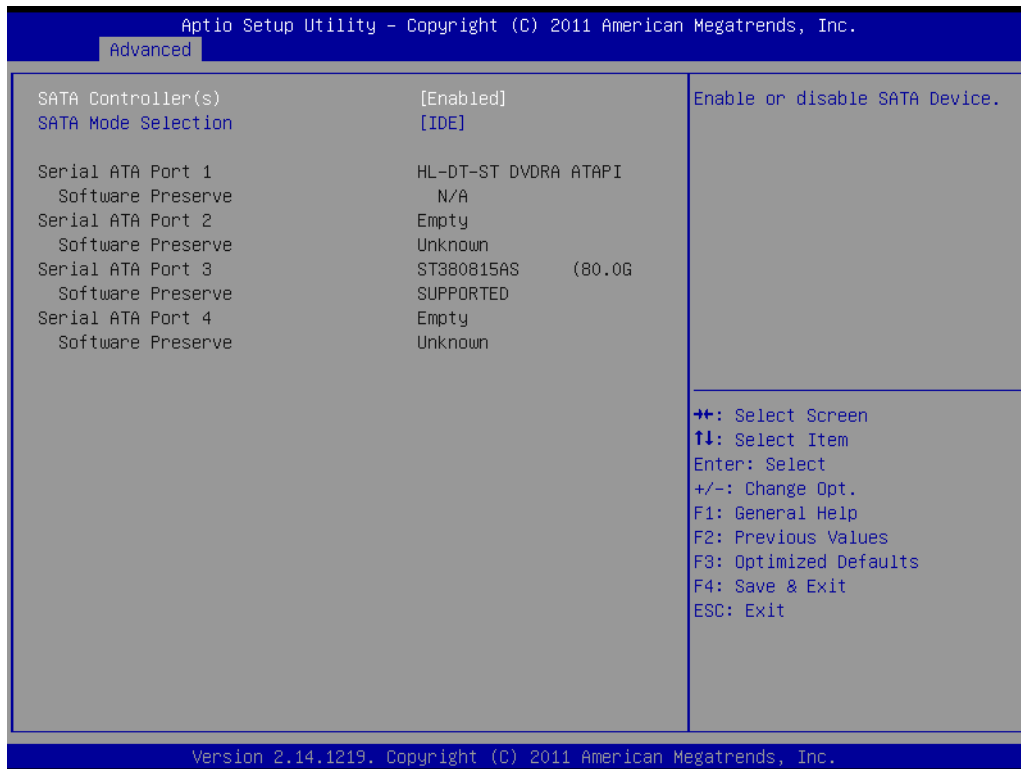

**Figure 3.8 SATA Configuration**

- **SATA Controller(s)**  
This item allows users to enable or disable the SATA controller(s).
- **SATA Mode Selection**  
This item allows users to select mode of SATA controller(s).

### 3.2.2.6 Intel® Rapid Start Technology

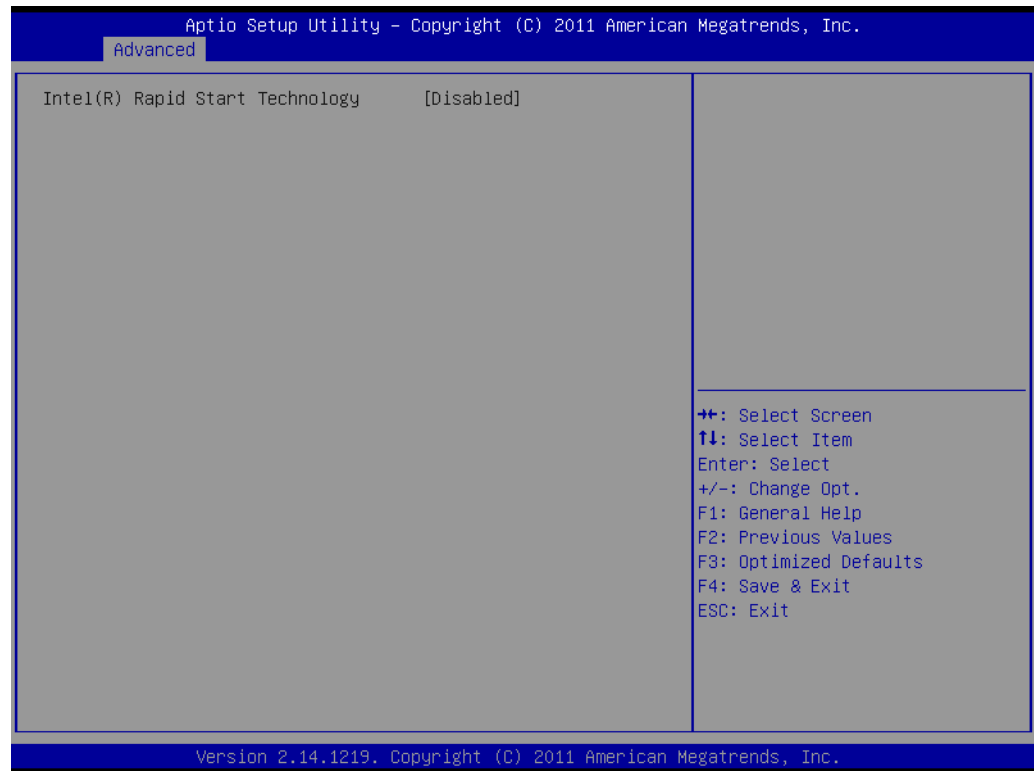
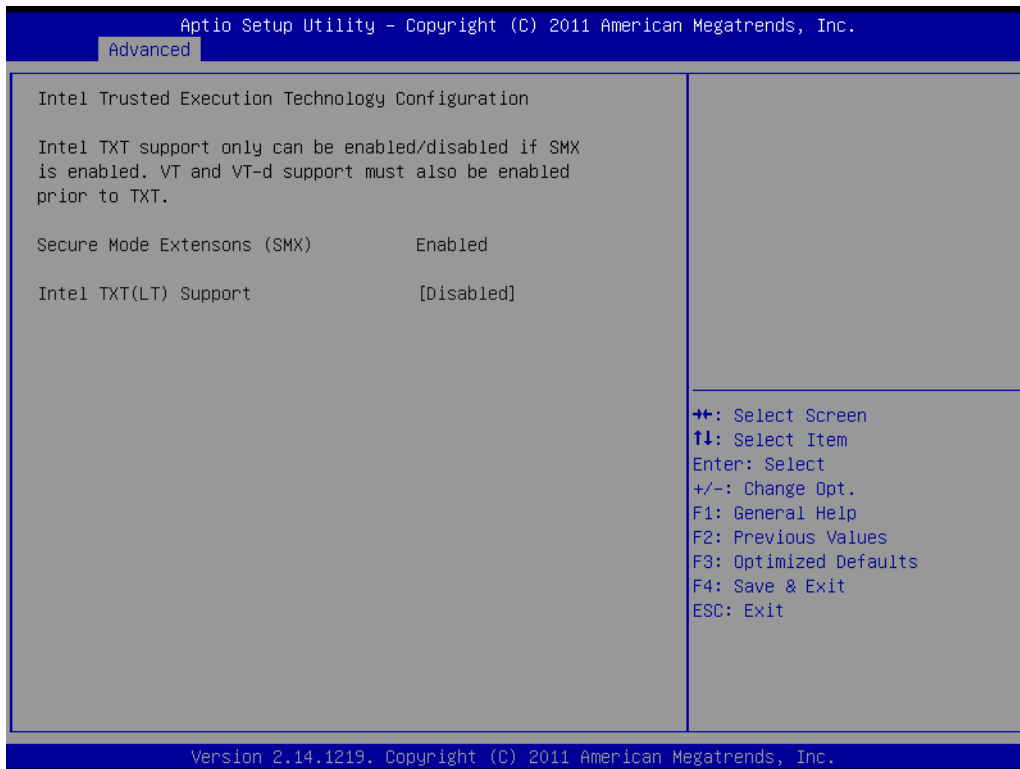

**Figure 3.9 Intel® Rapid Technology**

- **Intel® Rapid Start Technology**  
This item allows users to enable or disable Intel Rapid Start Technology.



### 3.2.2.7 Intel TXT(LT) Configuration



**Figure 3.10 Intel TXT(LT) Configuration**

- **Secure Mode Extensions (SMX)**  
This item allows users to enable or disable SMX.
- **Intel TXT(LT) Support**  
This item allows users to enable or disable Intel TXT.

### 3.2.2.8 PCH-FW Configuration

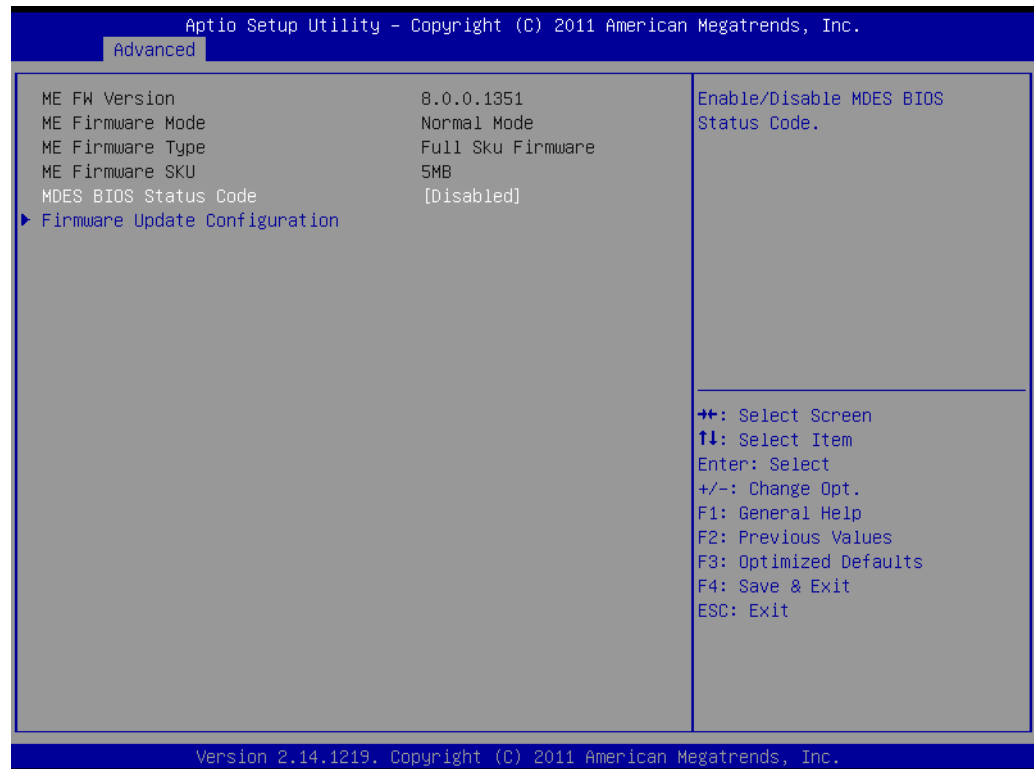

**Figure 3.11 PCH-FW Configuration**

- **MDES BIOS Status Code**

This item allows users to enable or disable MDES BIOS Status Code function.

## ■ Firmware Update Configuration

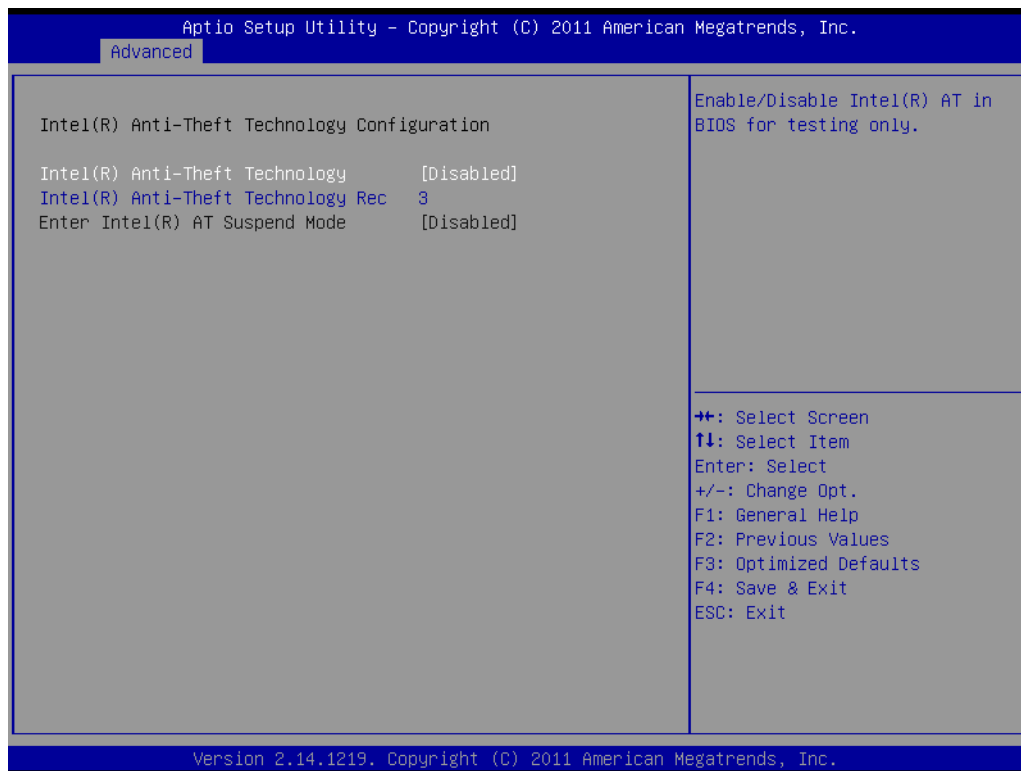

**Figure 3.12 Firmware Update Configuration**

## ■ Me FW Image Re-Flash

This item allows users to enable or disable Me FW image re-flash function.

### 3.2.2.9 Intel® Anti-Theft Technology Configuration



**Figure 3.13 Intel® Anti-Theft Technology Configuration**

- **Intel® Anti-Theft Technology**  
This item allows users to enable or disable the Intel Anti-Theft Technology function.
- **Intel® Anti-Theft Technology Rec**  
This item allows users to set the number of Recovery attempts allowed.
- **Enter Intel AT Suspend Mode**  
This item allows users to enable or disable to enter Intel AT suspend mode.

### 3.2.2.10 AMT Configuration

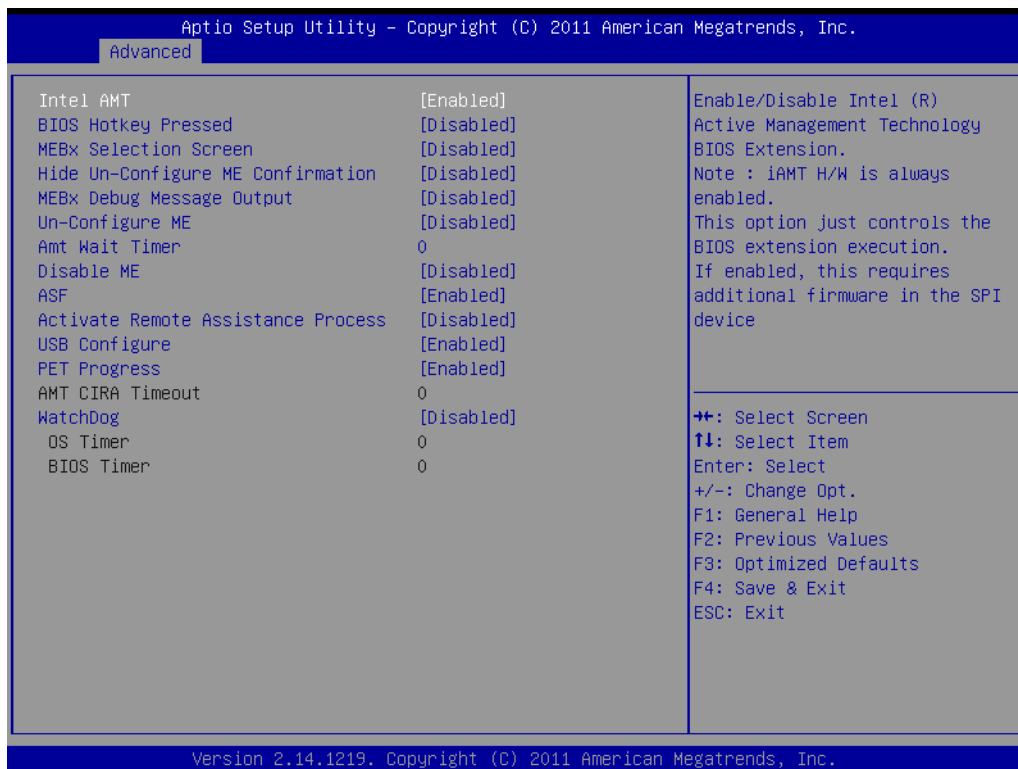

**Figure 3.14 AMT Configuration**

- **Intel AMT**  
This item allows users to enable or disable Intel AMT BIOS extension.
- **BIOS Hotkey Pressed**  
This item allows users to enable or disable BIOS hotkey press.
- **MEBx Selection Screen**  
This item allows users to enable or disable MEBx selection screen.
- **Hide Un-Configuration ME Confirmation**  
This item allows users to hide un-configure ME without password confirmation prompt.
- **MEBx Debug Message Output**  
This item allows users to enable or disable MEBx debug message.
- **Un-Configure ME**  
This item allows users to un-configure ME without password.
- **Amt Wait Timer**  
Set timer to wait before sending ASF\_GET\_BOOT\_OPTIONS.
- **Disable ME**  
This item allows users to enable or disable Intel ME.
- **ASF**  
This item allows users to enable or disable Alert Specification Format.
- **Activate Remote Assistance Process**  
This item allows users to enable or disable trigger CIRA boot.
- **USB Configure**  
This item allows users to enable or disable USB configure function.

- **PET Progress**  
This item allows users to enable or disable PET events progress to receive PET events or not.
- **AMT CIRA Timeout**  
OEM defined timeout for MPS connection to be established.
- **WatchDog**  
This item allows users to enable or disable WatchDog Timer.
- **OS Timer**  
Set OS watchdog timer.
- **BIOS Timer**  
Set BIOS watchdog timer.

### 3.2.2.11 USB Configuration

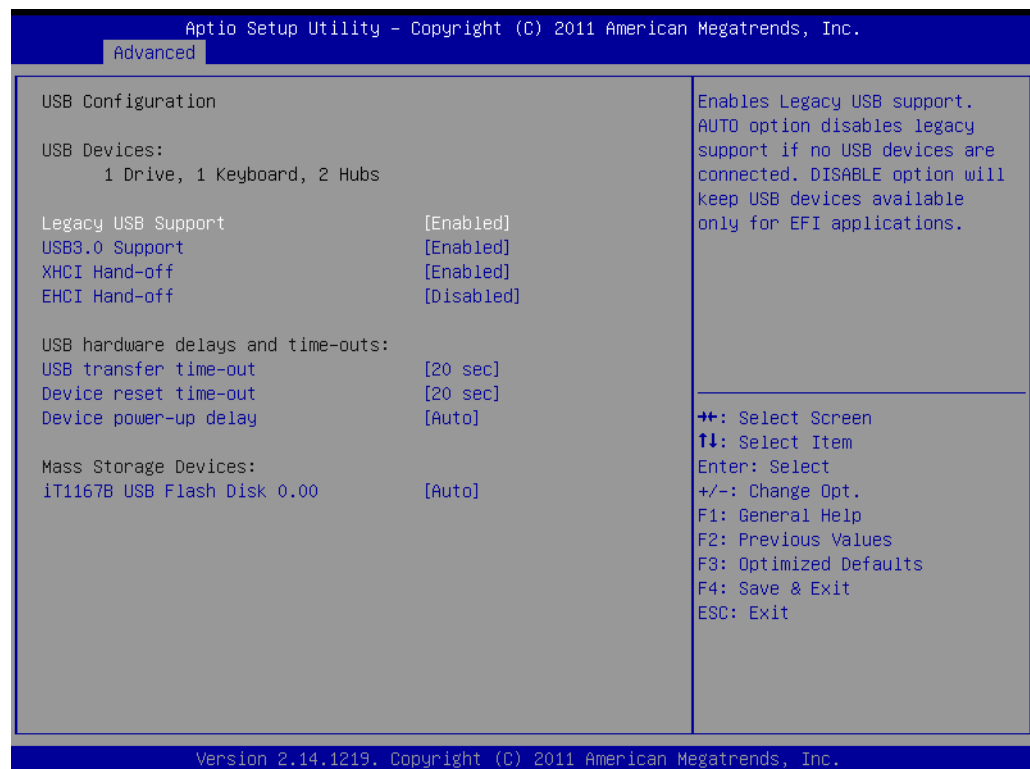
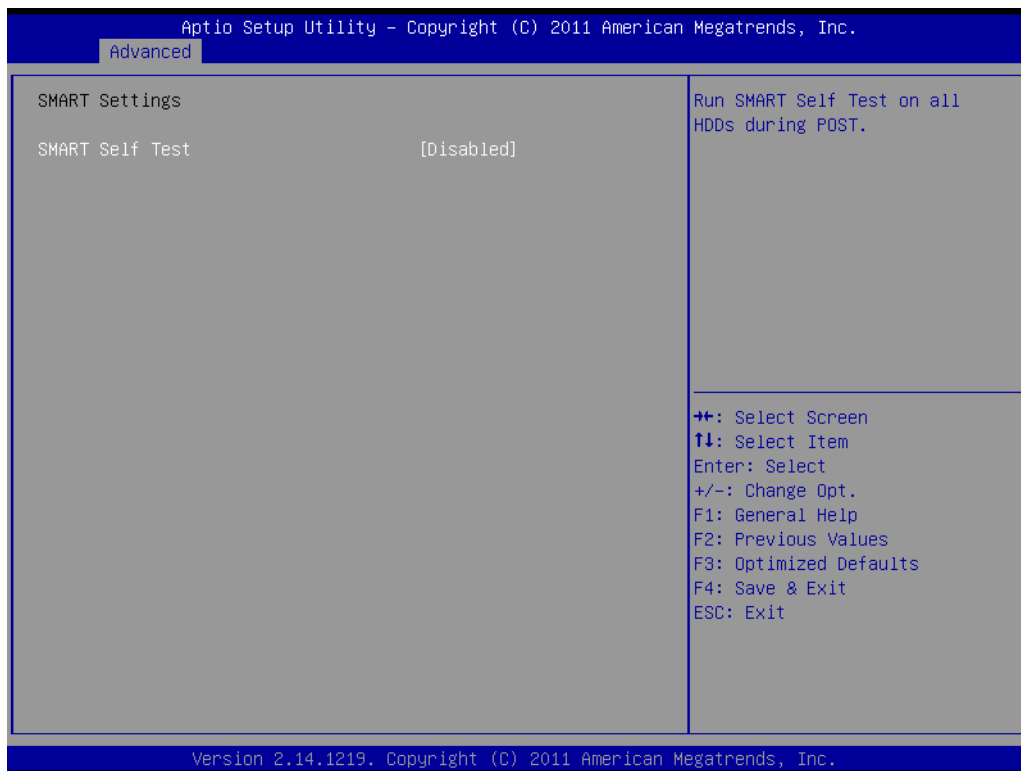

Figure 3.15 USB Configuration

- **Legacy USB Support**  
Enable the support for legacy USB. Auto option disables legacy support if no USB devices are connected.
- **USB3.0 Support**  
This item allows users to enable or disable USB3.0 support.
- **XHCI Hand-Off**  
This is a workaround for the OS without XHCI hand-off support. The XHCI ownership change should claim by XHCI driver.
- **EHCI Hand-Off**  
This is a workaround for the OS without EHCI hand-off support. The EHCI ownership change should claim by EHCI driver.
- **USB transfer time-out**  
Set the time-out value for Control, Bulk, and Interrupt transfers.

- **Device reset time-out**  
Set USB mass storage device Start Unit command time-out value.
- **Device power-up delay**  
Set the maximum time of the device will take before it properly reports itself to the Host Controller. 'Auto' uses default value: for a Root port it is 100 ms, for a Hub port the delay is taken from Hub descriptor.

### 3.2.2.12 SMART Settings



**Figure 3.16 SMART Settings**

- **SMART Self Test**  
This item allows users to enable or disable HDDs SMART Self Test during POST.

### 3.2.2.13 Embedded Controller Configuration

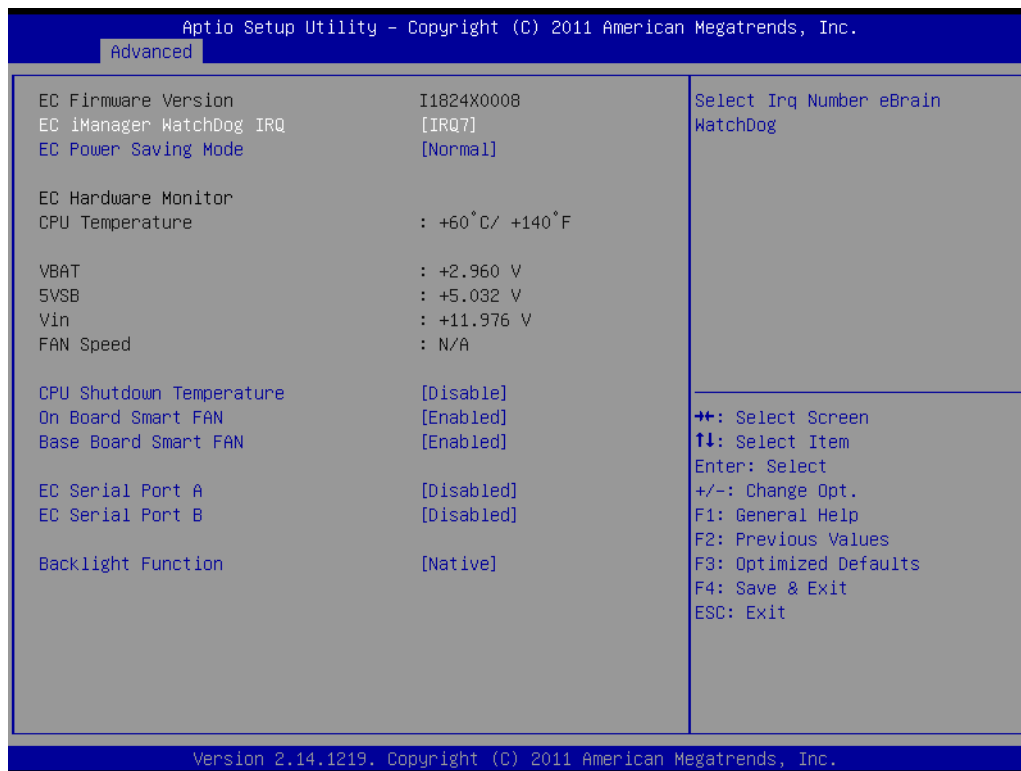
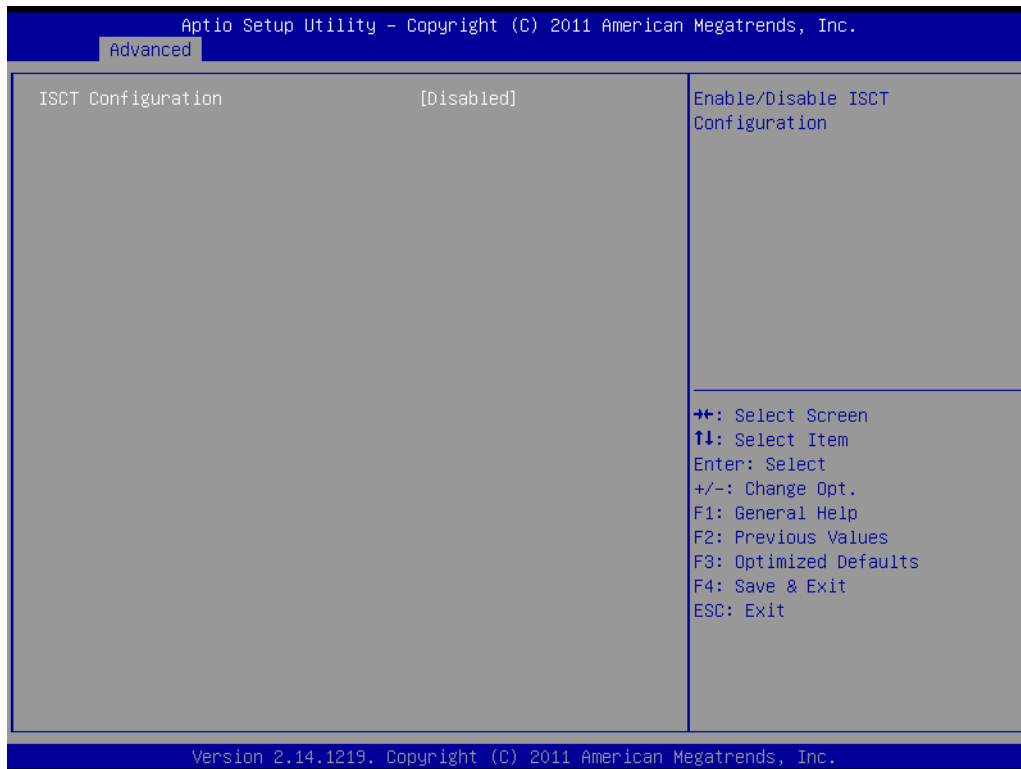

**Figure 3.17 Embedded Controller Configuration**

- **EC iManager WatchDog IRQ**  
This item allows users to set the irq number of EC watchdog.
- **EC Power Saving Mode**  
This item allows users to set board's power saving mode when off.
- **CPU Shutdown Temperature**  
This item allows users to set the value of CPU shutdown temperature.
- **On Board Smart FAN**  
This item allows users to enable or disable On Board smart FAN feature.
- **Base Board Smart FAN**  
This item allows users to enable or disable Base Board smart FAN feature.
- **EC Serial Port A**  
This item allows users to enable or disable EC serial port A.
- **EC Serial Port B**  
This item allows users to enable or disable EC serial port B.
- **Backlight Function**  
This item allows users to set backlight Function.



### 3.2.2.14 Intel® Smart Connect Technology



**Figure 3.18 Intel® Smart Connect Technology**

- **ISCT Configuration**  
This item allows users to enable or disable ISCT Configuration.

### 3.2.2.15 Super IO Configuration



**Figure 3.19 Super IO Configuration**

- **Serial Port 0 Configuration**

This item allows users to configure serial port 0.

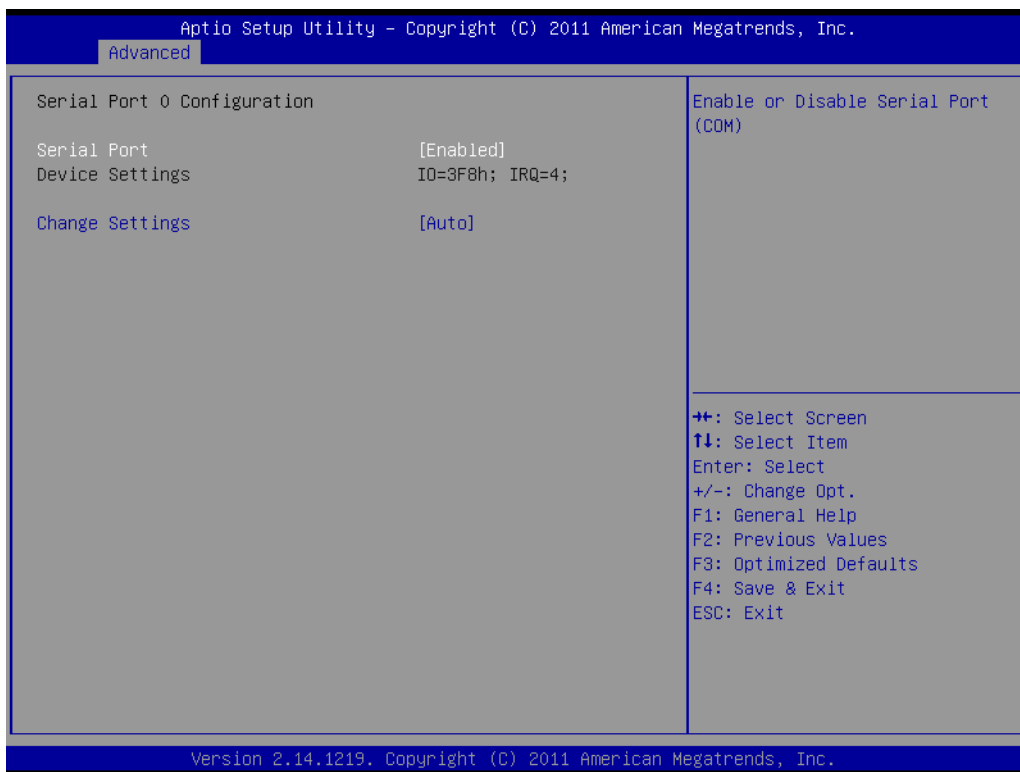

**Figure 3.20 Serial Port 0 Configuration**

- **Serial Port**

Serial port 0 enable or disable

- **Change settings**

Serial port 0 IRQ/IO/mode resources configuration. Users can choose IRQ,IO, and MODE.

- **Serial Port 1 Configuration**

This item allows users to configure serial port 1.

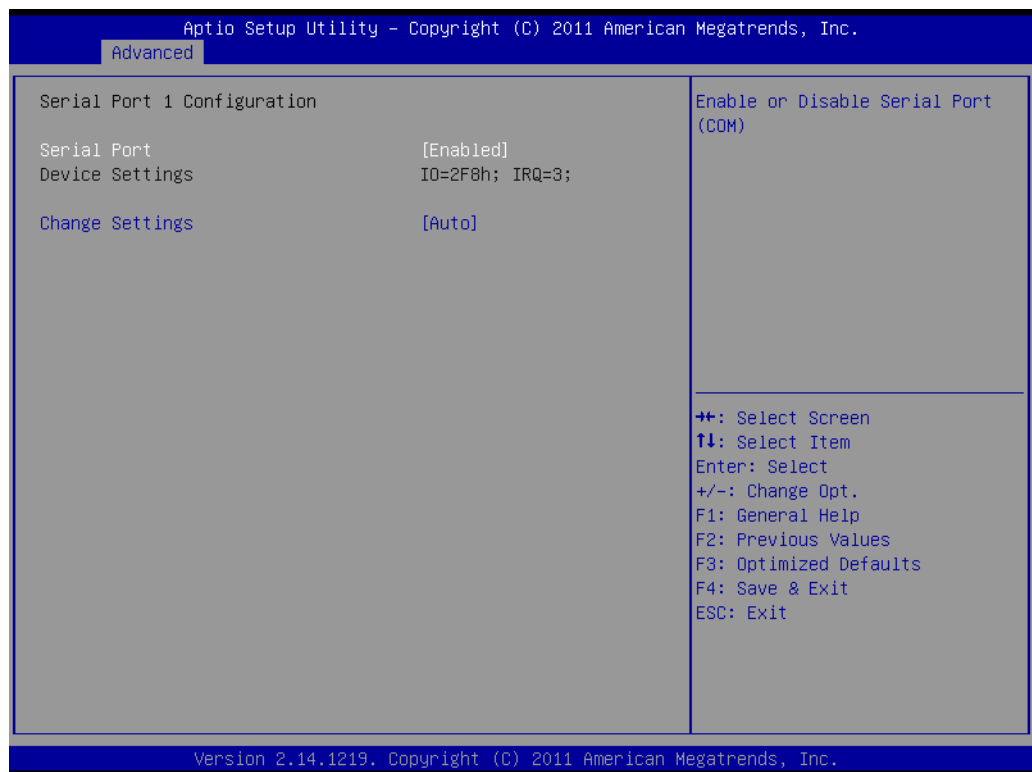

**Figure 3.21 Serial Port 1 Configuration**

- **Serial Port**

Serial port 1 enable or disable

- **Change settings**

Serial port 1 IRQ/IO/mode resources configuration. Users can choose IRQ,IO, and MODE.

- **Parallel Port Configuration**

This item allows users to configure parallel port.

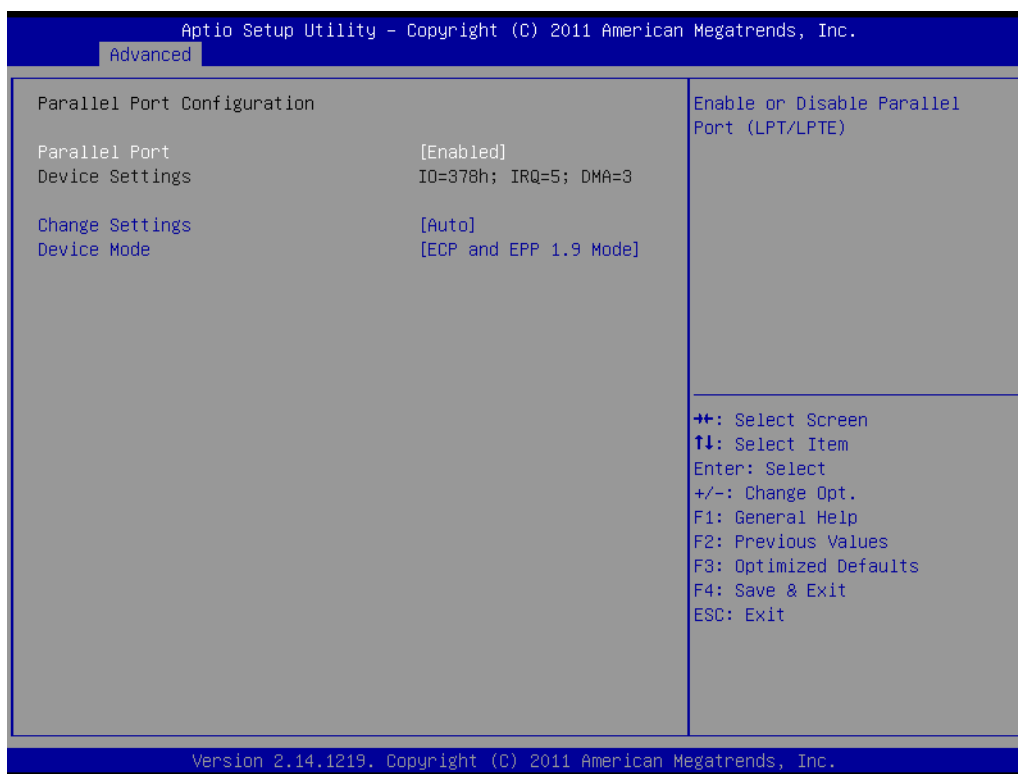

**Figure 3.22 Parallel Port Configuration**

- **Parallel Port**

This item allows to enable or disable parallel port

- **Change Settings**

This item allow parallel port resources include IRQ/IO configuration.

- **Device Mode**

Set parallel mode as EPP/ECP/STD/SPP

### 3.2.2.16 Serial Port Console Redirection

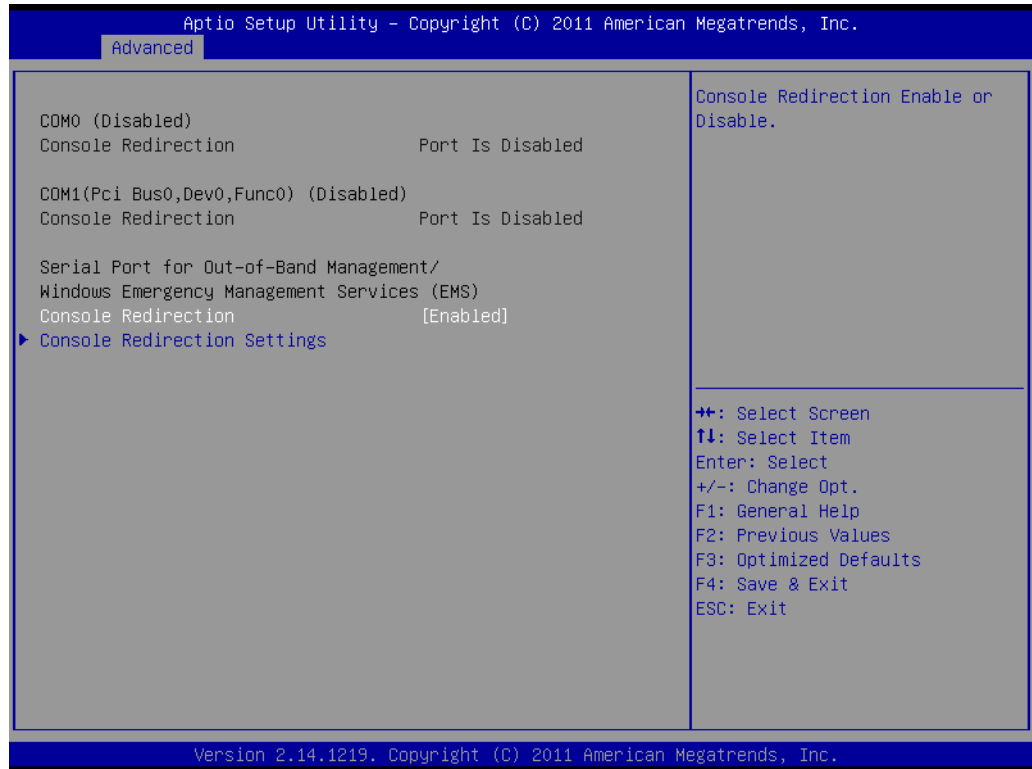

**Figure 3.23 Serial Port Console Redirection**

- **Console Redirection**  
This item allows users to enable or disable console redirection for Microsoft Windows Emergency Management Services (EMS).

## ■ Console Redirection Settings

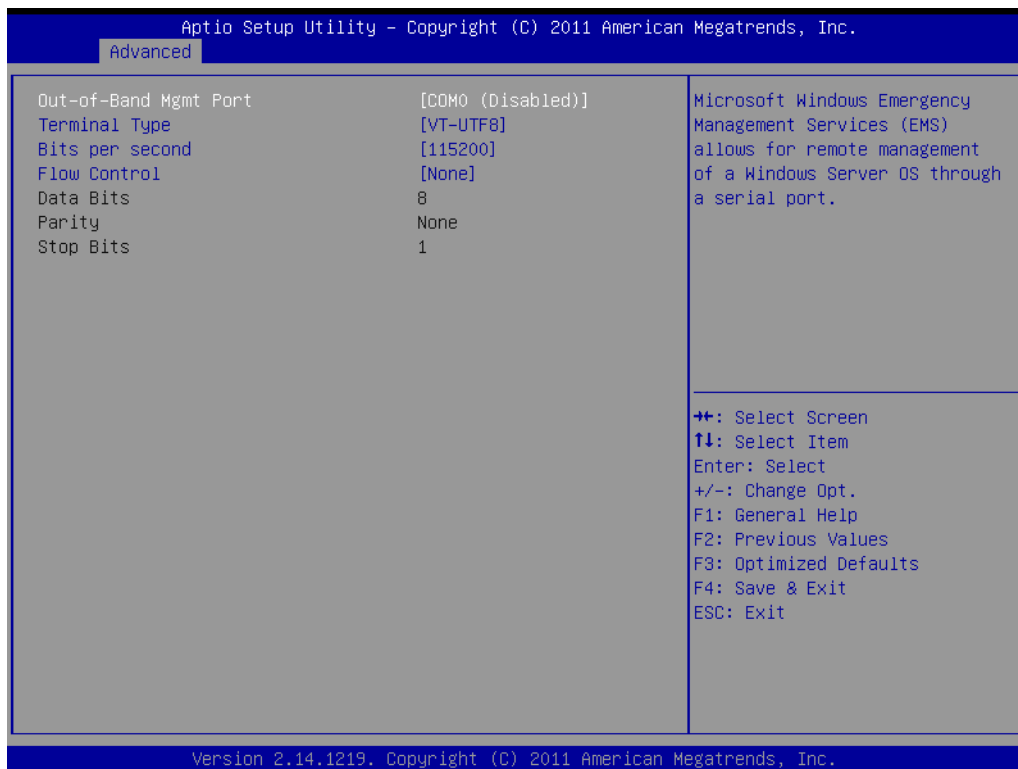

**Figure 3.24 Console Redirection Settings**

- **Out-of-Band Mgmt Port**  
Select the port for Microsoft Windows Emergency Management Services (EMS) to allow for remote management of a Windows Server OS.
- **Terminal Type**  
VT-UTF8 is the preferred terminal type for out-of-band management. The next best choice is VT100+ and then VT100. See above, in Console Redirection Settings page, for more Help with Terminal Type/Emulation.
- **Bits per second**  
Selects serial port transmission speed. The speed must be matched on the other side. Long or noisy lines may require lower speeds.
- **Flow Control**  
Flow control can prevent data loss from buffer overflow.

### 3.2.2.17 CPU PPM Configuration

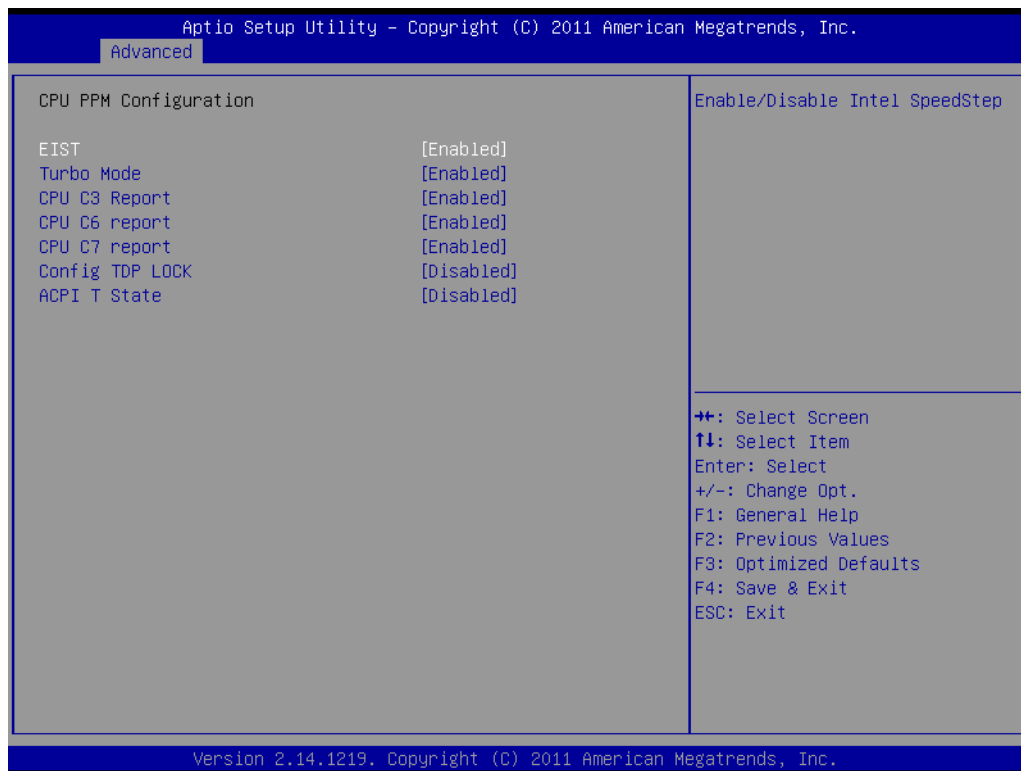

Figure 3.25 CPU PPM Configuration

- **EIST**  
CPU runs at its default speed if disabled; CPU speed is controlled by the operating system if enabled.
- **Turbo Mode**  
This item allows users to enable or disable turbo mode.
- **CPU C3/C6/C7 Report**  
This item allows users to enable or disable CPU C-state support.
- **Config TDP LOCK**  
This item allows users to enable or disable Config TDP LOCK.
- **ACPI T State**  
This item allows users to enable or disable ACPI T State.



### 3.2.2.18 Switchable Graphics

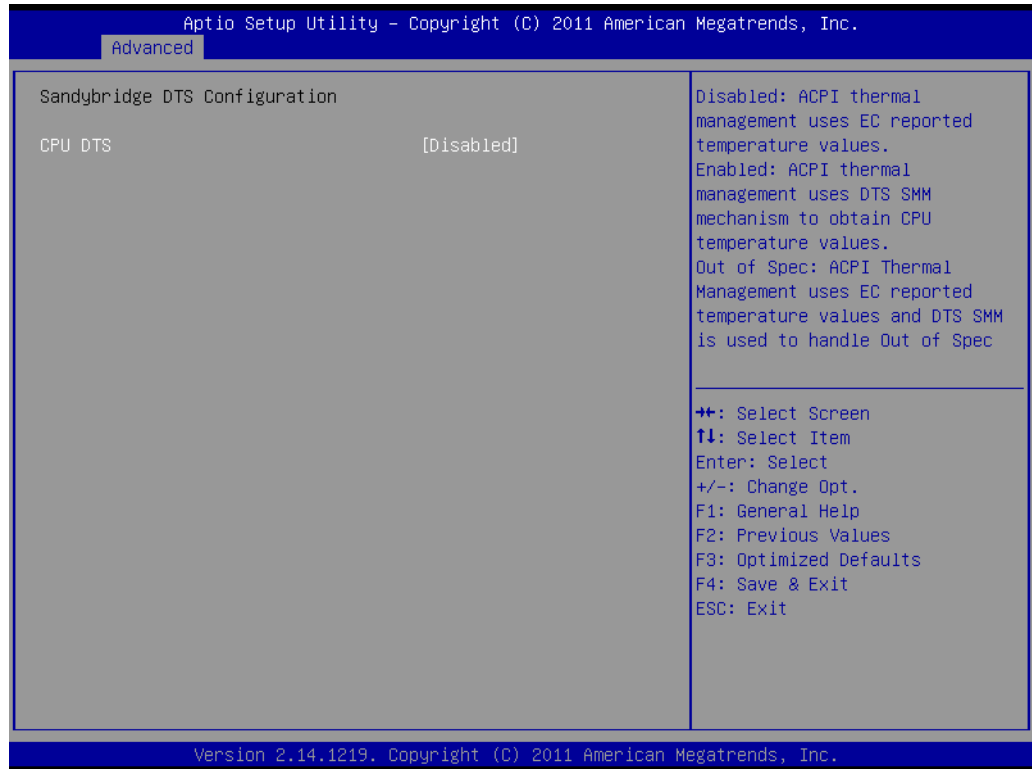

**Figure 3.26 Switchable Graphics**

- **SG Mode Select**

This item allows users to select switchable graphics mode.

### 3.2.2.19 Sandybridge DTS Configuration



**Figure 3.27 Sandybridge DTS Configuration**

- **CPU DTS**  
This item allows users to enable or disable CPU DTS.

### 3.2.3 Chipset

Select the Chipset tab from the SOM-5892 setup screen to enter the Chipset BIOS Setup screen. You can display a Chipset BIOS Setup option by highlighting it using the <Arrow> keys. All Plug and Play BIOS Setup options are described in this section. The Plug and Play BIOS Setup screen is shown below.



**Figure 3.28 Chipset Setup**

### 3.2.3.1 PCH-IO Configuration

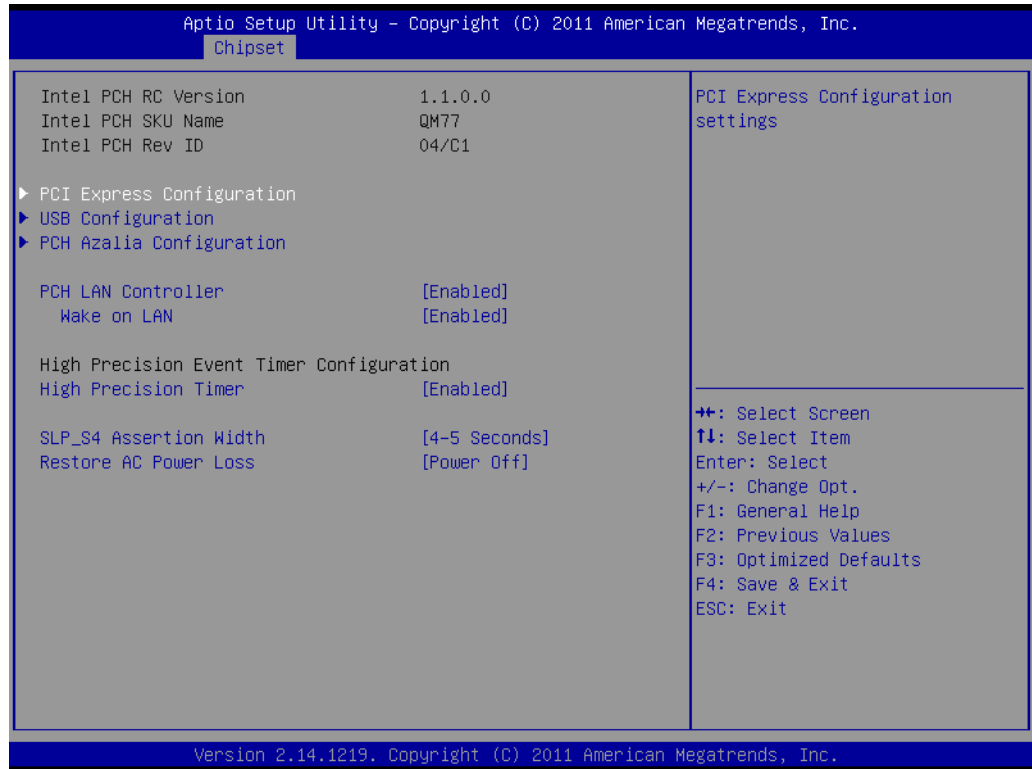
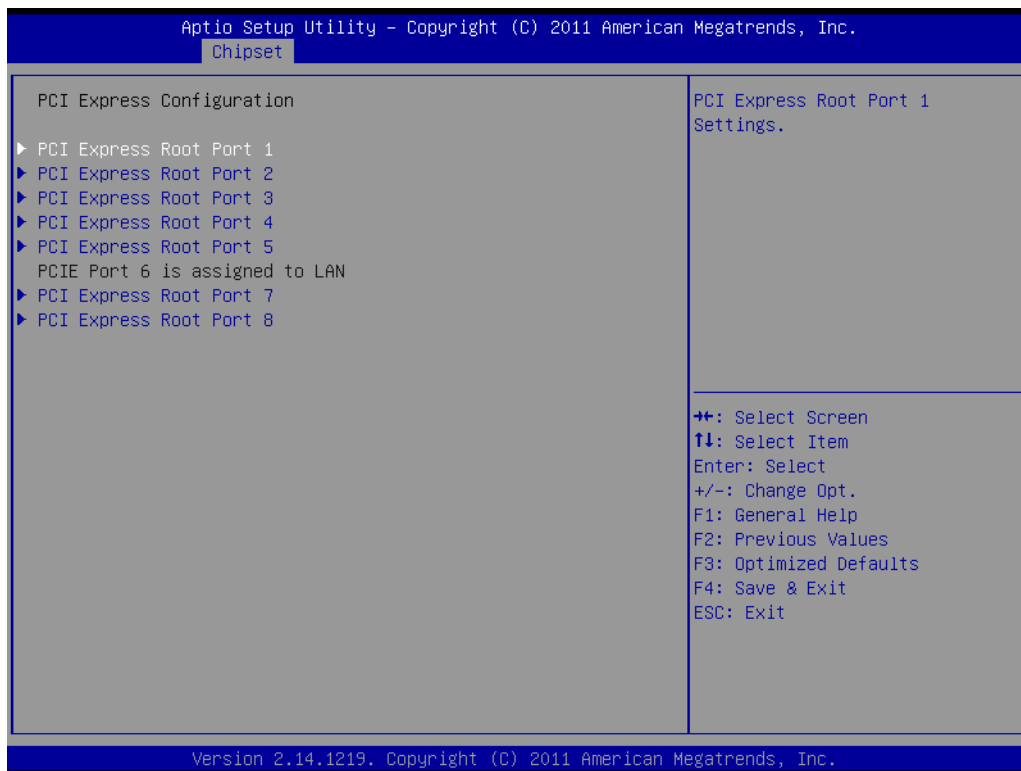

Figure 3.29 PCH-IO Configuration

- **PCH LAN controller**  
Enables or disables the PCH LAN controller.
- **Wake on LAN**  
Enables or disables PCH LAN wake up from sleep state.
- **High Precision Timer**  
Enables or disables the high precision timer.
- **SLP\_S4 Assertion Width**  
This item allows users to set a delay of sorts.
- **Restore AC Power Loss**  
This item allows users to select off, on and last state.

## ■ PCI Express Configuration

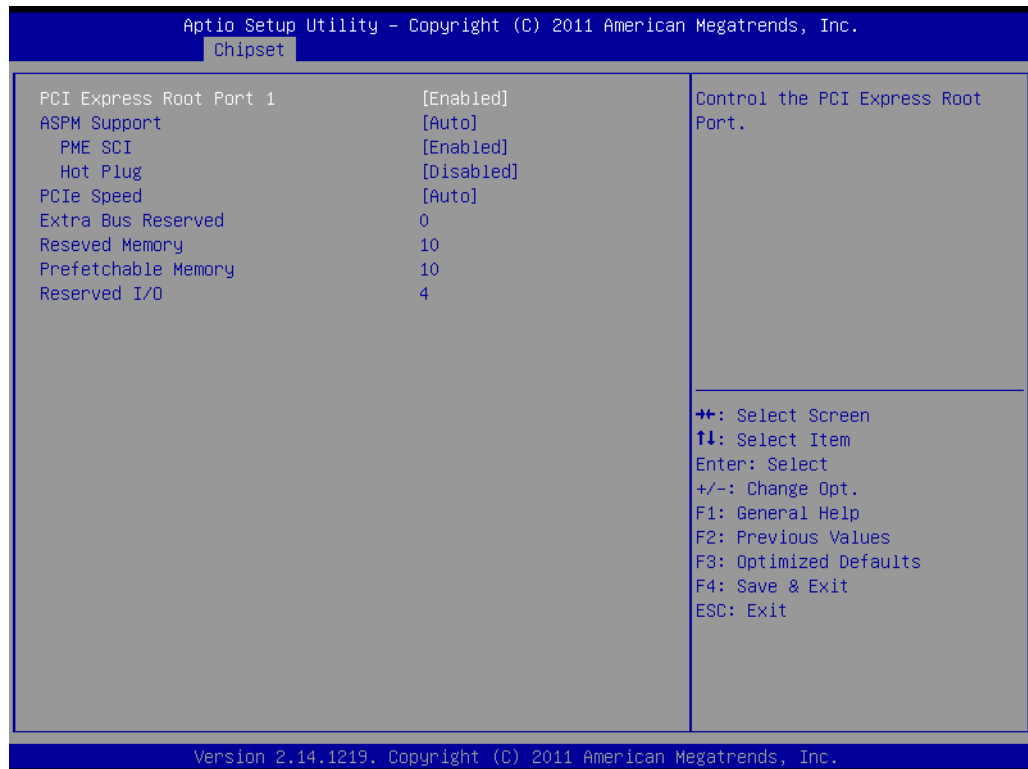

**Figure 3.30 PCI Express Configuration**

### PCI Express Root Port x

This item allows users to configure PCI express ports.

## – PCI Express Root Port 1



**Figure 3.31 PCI Express Root Port 1**

### **PCI Express Root Port 1**

Control the PCI Express Root Port.

#### **ASPM Support**

Sets ASPM level.

#### **PME SCI**

Enable or disable PCI Express PME SCI

#### **Hot Plug**

Enable or disable Hot Plug

#### **PCIe Speed**

Select PCI Express port speed, default auto.

#### **Extra Bus Reserved**

Extra bus Reserved for bridges behind this root bridge.

#### **Reserved Memory**

Reserved Memory Range for this root bridge

#### **Prefetchable Memory**

Prefetchable Memory Range for this root bridge.

#### **Reserved I/O**

Reserved I/O Range for this root bridge.

## – PCI Express Root Port 2

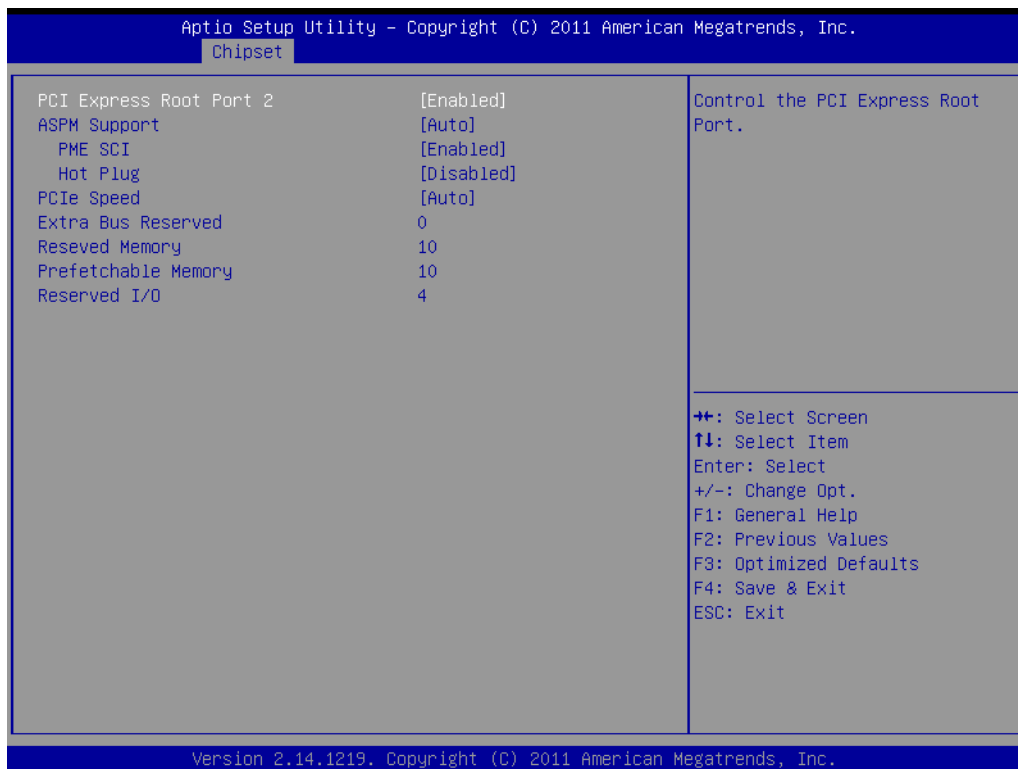

**Figure 3.32 PCI Express Root Port 2**

### PCI Express Root Port 2

Control the PCI Express Root Port 2.

#### ASPM Support

Sets ASPM level.

#### PME SCI

Enable or disable PCI Express PME SCI

#### Hot Plug

Enable or disable Hot Plug

#### PCIe Speed

Select PCI Express port speed, default auto.

#### Extra Bus Reserved

Extra bus Reserved for bridges behind this root bridge.

#### Reserved Memory

Reserved Memory Range for this root bridge.

#### Prefetchable Memory

Prefetchable Memory Range for this root bridge.

#### Reserved I/O

Reserved I/O Range for this root bridge.

## – PCI Express Root Port 3

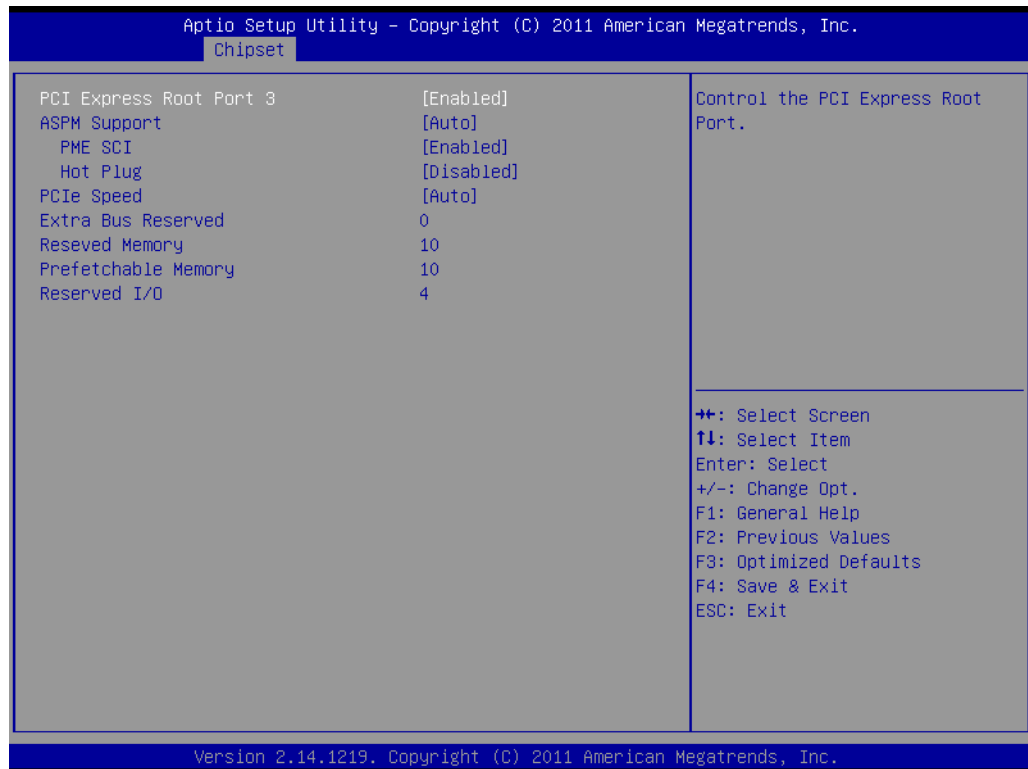

**Figure 3.33 PCI Express Root Port 3**

### **PCI Express Root Port 3**

Control the PCI Express Root Port 3.

#### **ASPM Support**

Set sASPM level.

#### **PME SCI**

Enable or disable PCI Express PME SCI

#### **Hot Plug**

Enable or disable Hot Plug

#### **PCIe Speed**

Select PCI Express port speed, default auto.

#### **Extra Bus Reserved**

Extra bus Reserved for bridges behind this root bridge.

#### **Reserved Memory**

Reserved Memory Range for this root bridge.

#### **Prefetchable Memory**

Prefetchable Memory Range for this root bridge.

#### **Reserved I/O**

Reserved I/O Range for this root bridge.



## – PCI Express Root Port 4

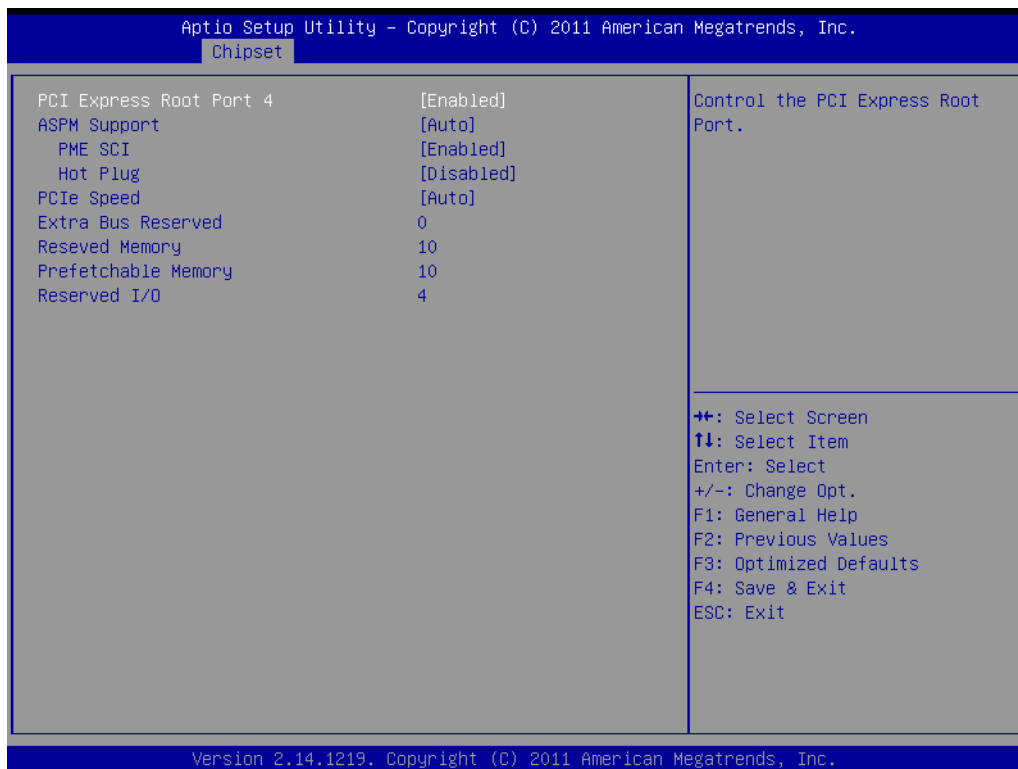

**Figure 3.34 PCI Express Root Port 4**

### PCI Express Root Port 4

Control the PCI Express Root Port 4.

#### ASPM Support

Sets ASPM level.

#### PME SCI

Enable or disable PCI Express PME SCI

#### Hot Plug

Enable or disable Hot Plug

#### PCIe Speed

Select PCI Express port speed, default auto.

#### Extra Bus Reserved

Extra bus Reserved for bridges behind this root bridge.

#### Reserved Memory

Reserved Memory Range for this root bridge.

#### Prefetchable Memory

Prefetchable Memory Range for this root bridge.

#### Reserved I/O

Reserved I/O Range for this root bridge.

## – PCI Express Root Port 5

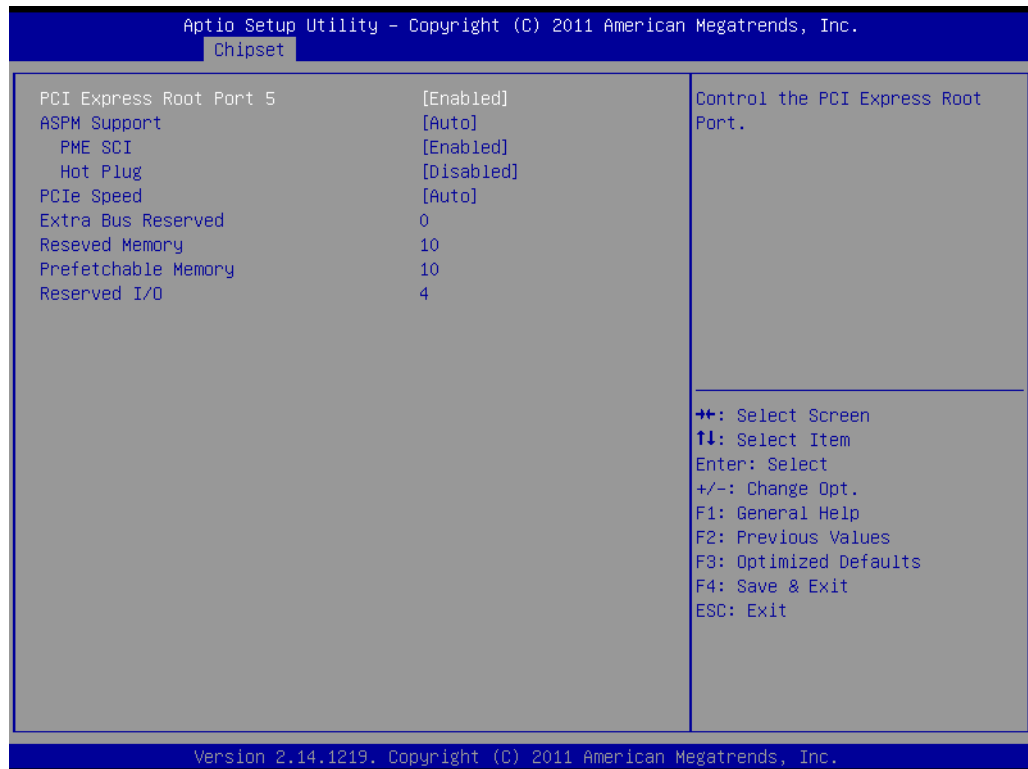

**Figure 3.35 PCI Express Root Port 5**

### **PCI Express Root Port 5**

Control the PCI Express Root Port 5.

#### **ASPM Support**

Set ASPM level.

#### **PME SCI**

Enable or disable PCI Express PME SCI

#### **Hot Plug**

Enable or disable Hot Plug

#### **PCIe Speed**

Select PCI Express port speed, default auto.

#### **Extra Bus Reserved**

Extra bus Reserved for bridges behind this root bridge.

#### **Reserved Memory**

Reserved Memory Range for this root bridge.

#### **Prefetchable Memory**

Prefetchable Memory Range for this root bridge.

#### **Reserved I/O**

Reserved I/O Range for this root bridge.

## – PCI Express Root Port 7

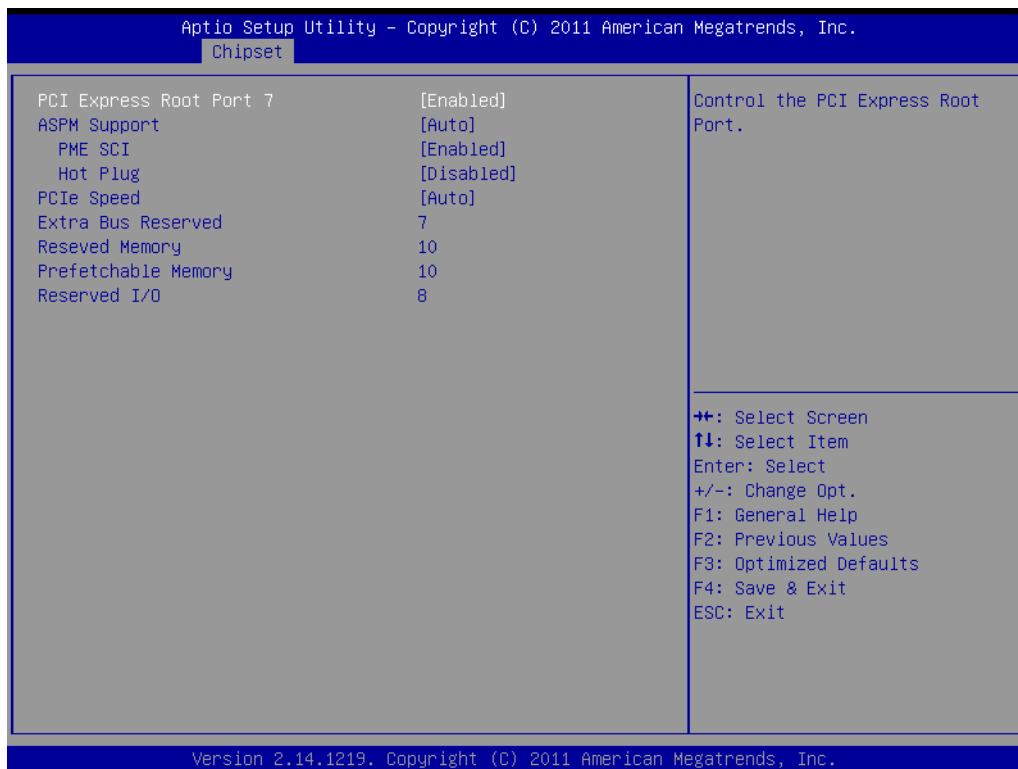

Figure 3.36 PCI Express Root Port 7

**PCI Express Root Port 7**

Control the PCI Express Root Port 7.

**ASPM Support**

Sets ASPM level.

**PME SCI**

Enable or disable PCI Express PME SCI

**Hot Plug**

Enable or disable Hot Plug

**PCIe Speed**

Select PCI Express port speed, default auto.

**Extra Bus Reserved**

Extra bus Reserved for bridges behind this root bridge.

**Reserved Memory**

Reserved Memory Range for this root bridge.

**Prefetchable Memory**

Prefetchable Memory Range for this root bridge.

**Reserved I/O**

Reserved I/O Range for this root bridge.

## – PCI Express Root Port 8

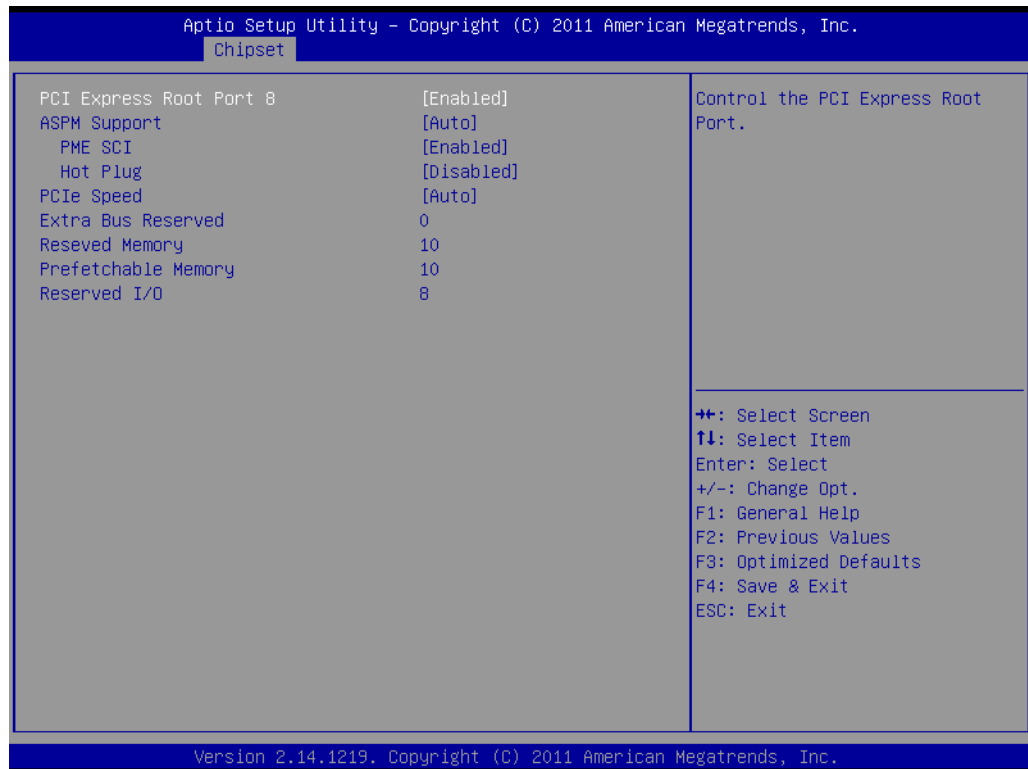

**Figure 3.37 PCI Express Root Port 8**

### **PCI Express Root Port 8**

Control the PCI Express Root Port 8.

#### **ASPM Support**

Sets ASPM level.

#### **PME SCI**

Enable or disable PCI Express PME SCI

#### **Hot Plug**

Enable or disable Hot Plug

#### **PCIe Speed**

Select PCI Express port speed, default auto.

#### **Extra Bus Reserved**

Extra bus Reserved for bridges behind this root bridge.

#### **Reserved Memory**

Reserved Memory Range for this root bridge.

#### **Prefetchable Memory**

Prefetchable Memory Range for this root bridge.

#### **Reserved I/O**

Reserved I/O Range for this root bridge.

## ■ USB Configuration

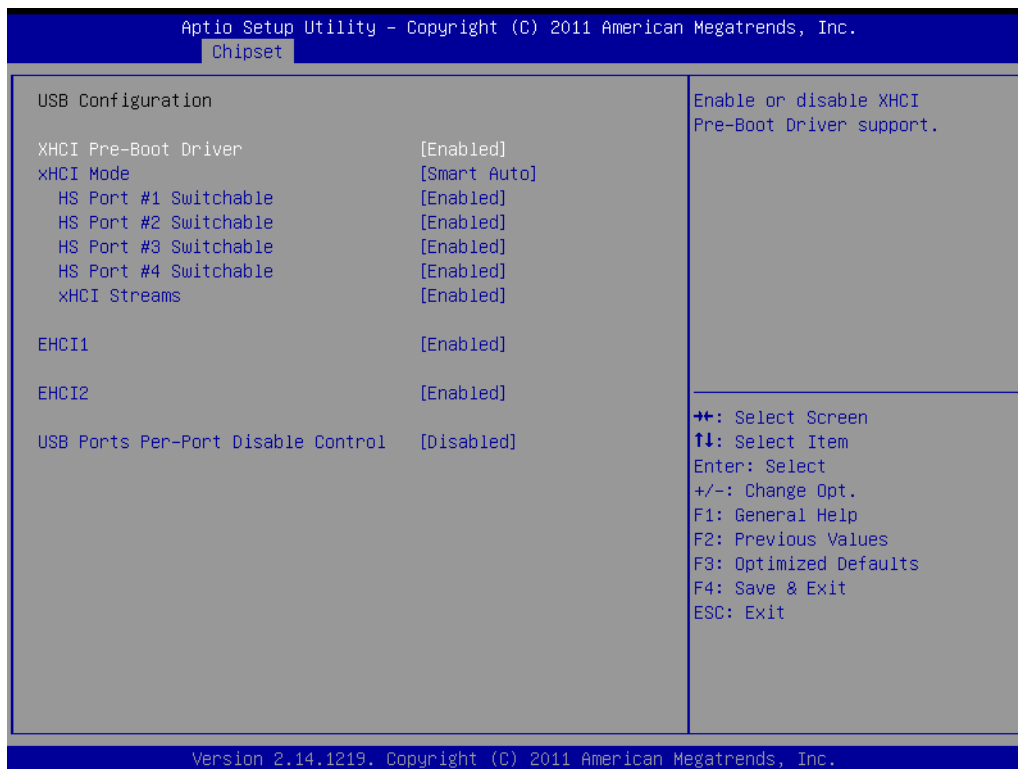

**Figure 3.38 USB Configuration**

- **XHCI Pre-Boot Driver**  
Enable or disable XHCI Pre-Boot Driver support
- **XHCI Mode**  
Mode of operation of XHCI controller.
- **HS Port #1/#2/#3/#4 switchable**  
Allows for HS port switching between XHCI and EHCI.
- **XHCI Streams**  
Enable or disable XHCI Maximum Primary Stream Array Size.
- **EHCI1/EHCI2**  
Enables or disables the EHCI controller.
- **USB Ports Per-Port Disable Control**  
This item allows users to enable or disable each USB port individually.

## ■ PCH Azalia Configuration



**Figure 3.39 PCH Azalia Configuration**

- **Azalia**  
This item allows to enable or disable PCH Azalia controller
- **Azalia Internal HDMI Codec**  
Enables or disables the Azalia internal HDMI codec.

### 3.2.3.2 System Agent (SA) Configuration

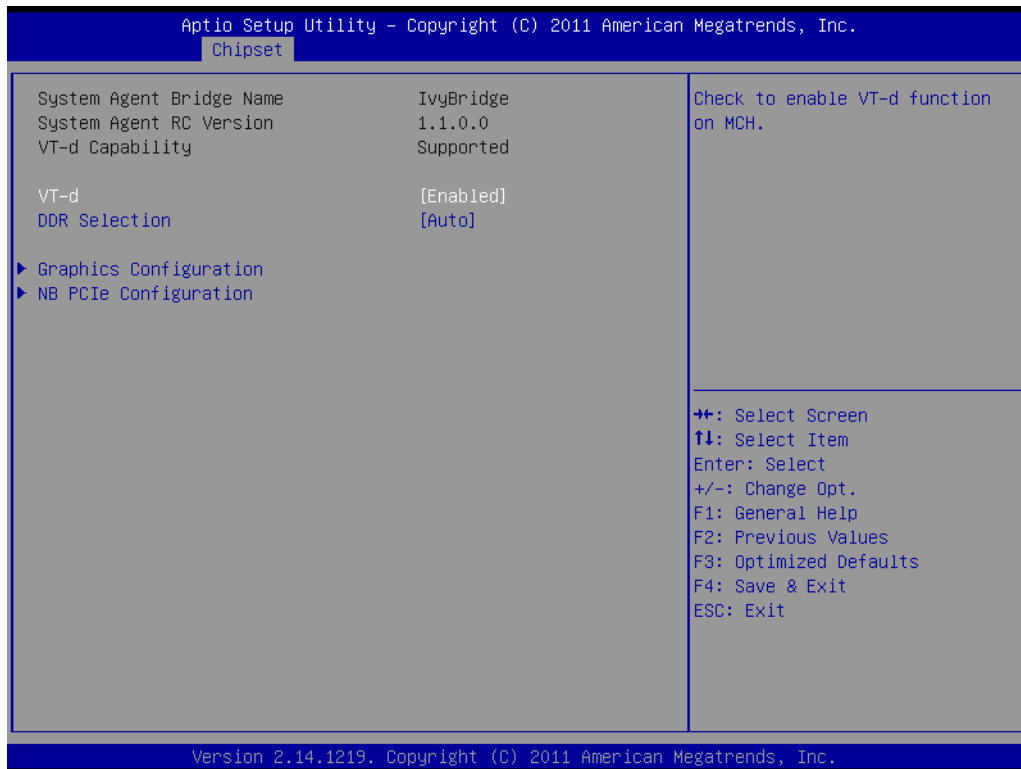

**Figure 3.40 System Agent (SA) Configuration**

- **VT-d**  
This item allows users to enable or disable VT-d.
- **DDR Selection**  
This item allows users to select which DDR or DDRL voltage.

## ■ Intel IGFX Configuration

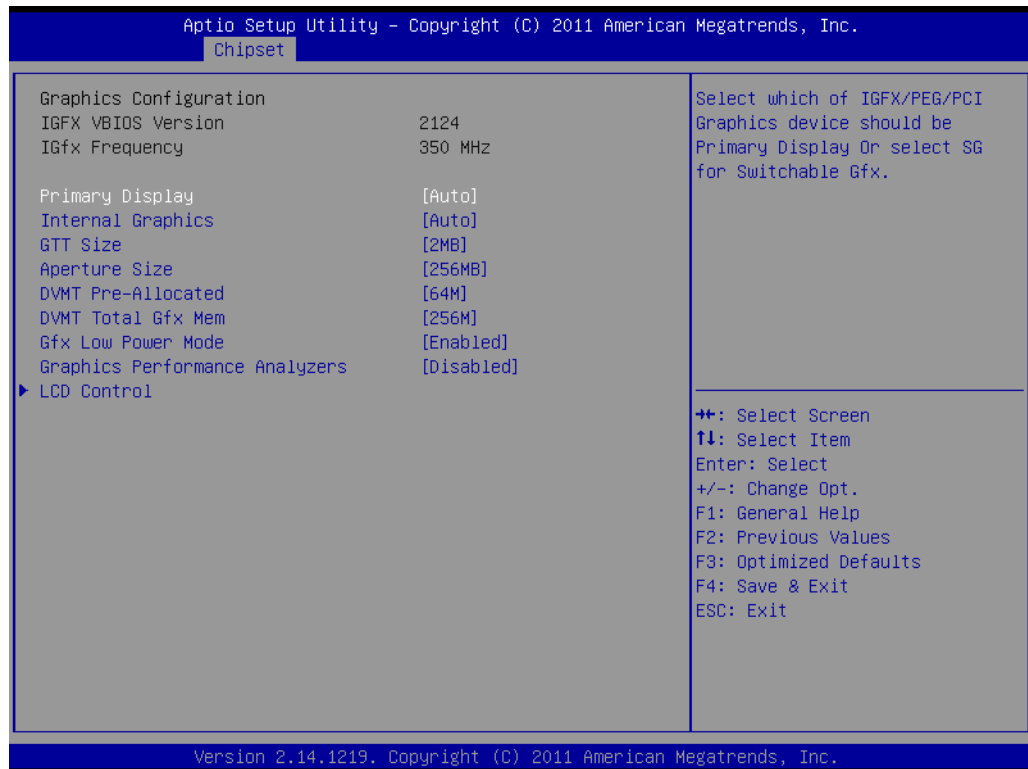

**Figure 3.41 Intel IGFX Configuration**

- **Primary Display**  
This item allows users to select Primary Display.
- **Internal Graphics**  
This item allows users to enable or disable IGD.
- **GTT Size**  
This item allows users to select GTT size.
- **Aperture Size**  
This item allows users to select aperture size.
- **DVMT Pre-Allocated**  
This item allows users to select DVMT pre-allocated memory size.
- **DVMT Total Gfx Mem**  
This item allows users to select DVMT total memory size.
- **Gfx Low Power Mode**  
This item allows users to enable or disable IGD low power mode.
- **Graphics Performance Analyzers**  
This item allows users to enable or disable Graphics Performance Analyzers



## – LCD Control



Figure 3.42 LCD Control

**Primary IGFX Boot Display**

Select boot display device at post stage.

**LCD Panel Type**

This item allows users to select panel resolution.

**Panel Scaling**

This item allows users to enable or disable panel scaling.

**Active LFP**

This item allows users to select LFP configuration.

– NB PCIe Configuration

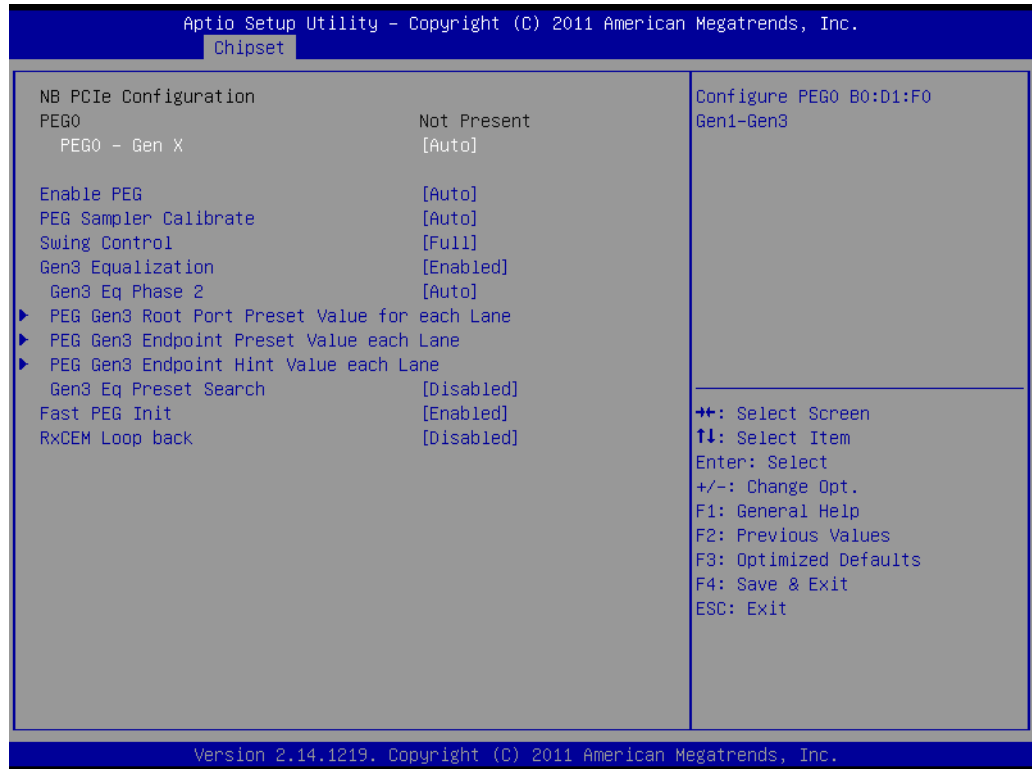

Figure 3.43 NB PCIe Configuration

**PEG0 - Gen x**

Select PEG0 speed.

**Enable PEG**

This item allows users to enable or disable PEG always.

**PEG Sampler Calibrate**

Enable or disable PEG sampler calibrate.

**Swing Control**

Perform PEG Swing Control.

**Gen3 Equalization**

Perform PEG Equalization steps.

**Gen3 Eq Phase 2**

Perform PEG Equalization phase 2.

**Gen3 Eq Preset Search**

Perform PEG Gen3 Preset Search algorithm.

**Fast PEG Init**

Enable or disable Fast PEG Initial.

**RxCEM Loop back**

Enable or disable RxCEM Loop back.

## PEG Gen3 Root Port Preset Value for each Lane

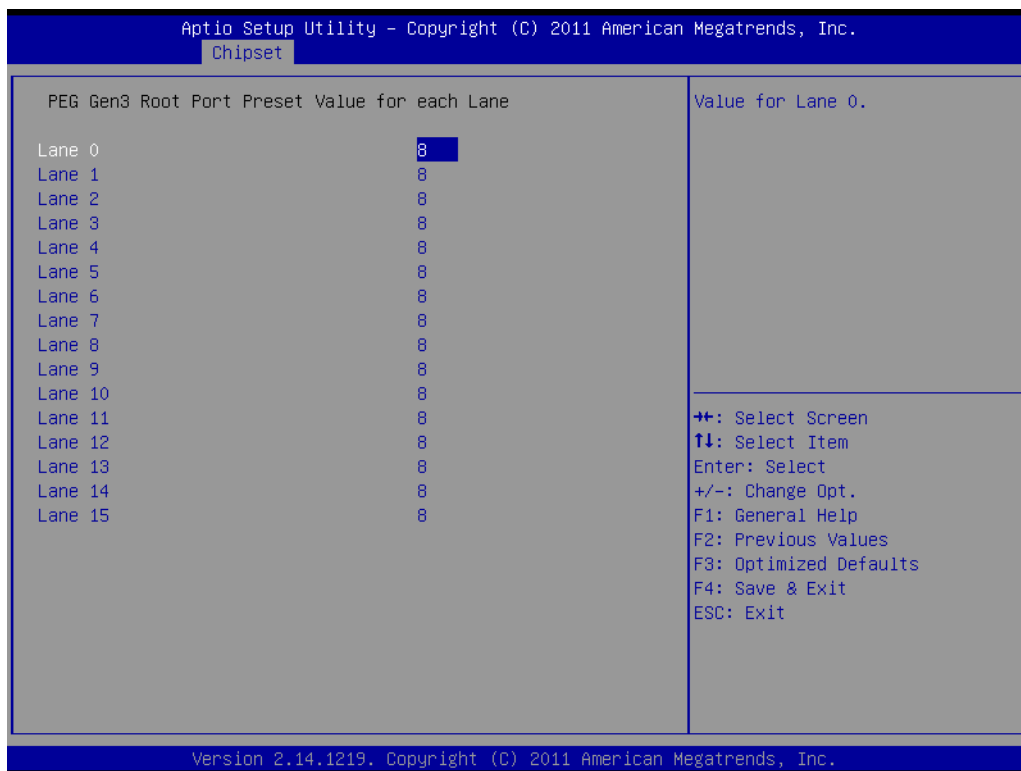
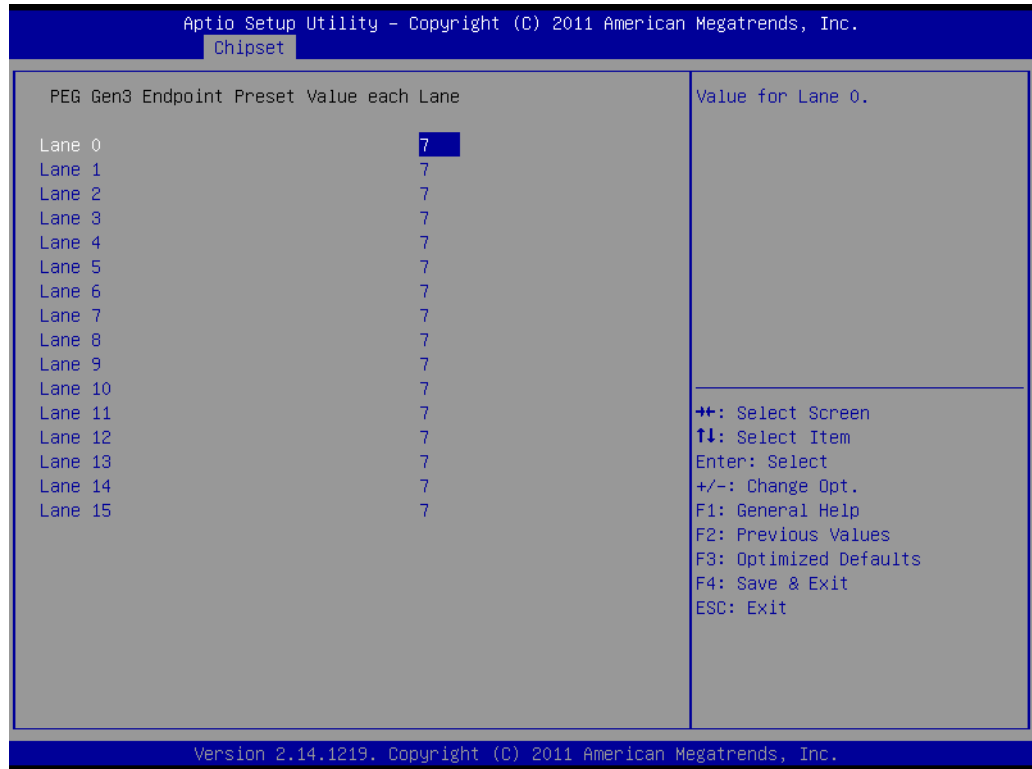

**Figure 3.44 PEG Gen3 Root Port Preset Value for each Lane**

### PEG Gen3 Root Port Preset Value for each Lane

Value for Lane x from 1-11, default as 8.

## PEG Gen3 Endpoint Preset Value each Lane

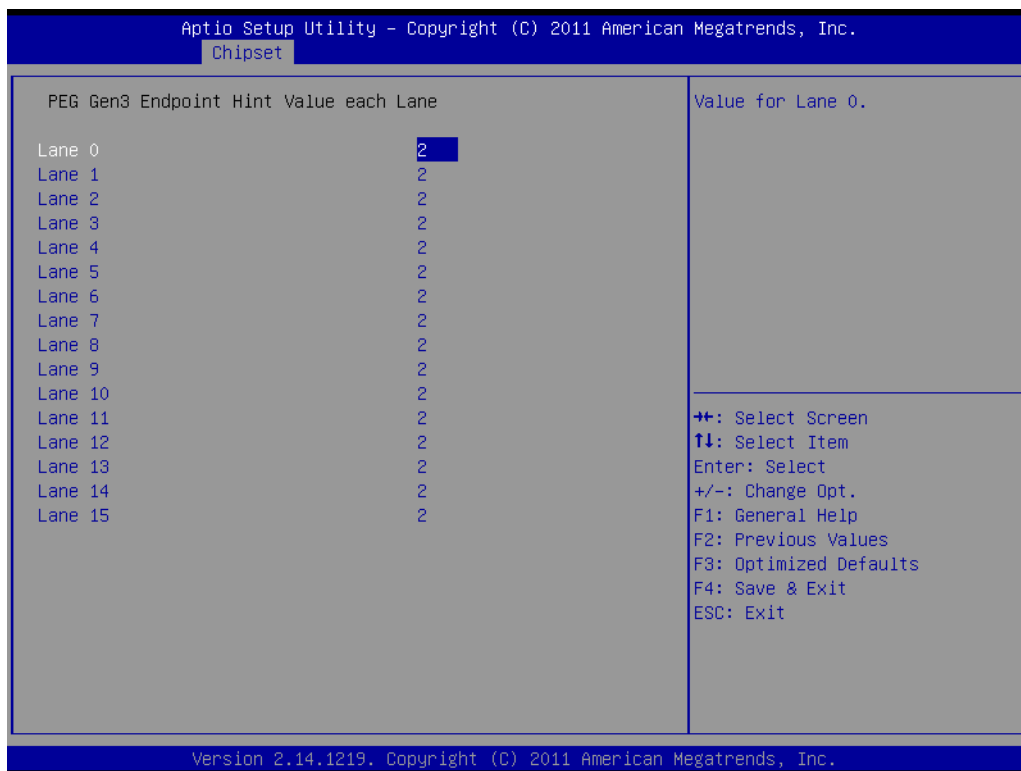

**Figure 3.45 PEG Gen3 Endpoint Preset Value each Lane**

### PEG Gen3 Endpoint Preset value each Lane

Value for Lane x from 0 - 11, default as 7.

## PEG Gen3 Endpoint Hint Value each Lane



**Figure 3.46 PEG Gen3 Endpoint Hint Value each Lane**

### PEG Gen3 Endpoint Hint Value each Lane

Value for Lane x from 0 - 7, default as 2.

## 3.2.4 Boot Settings

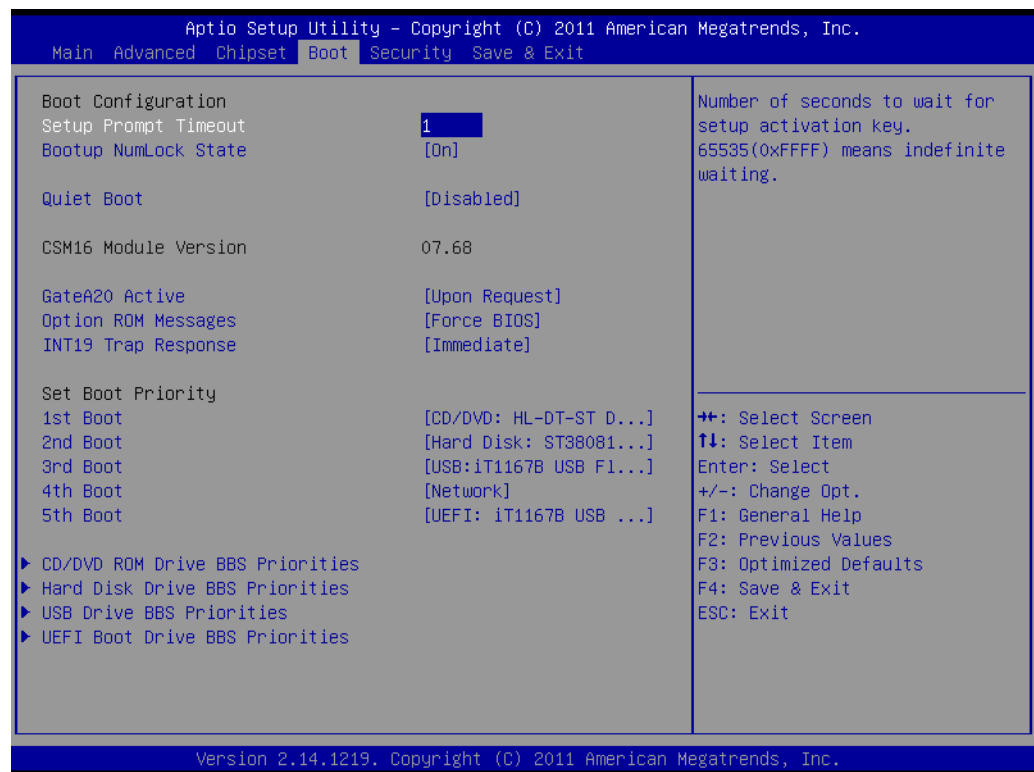
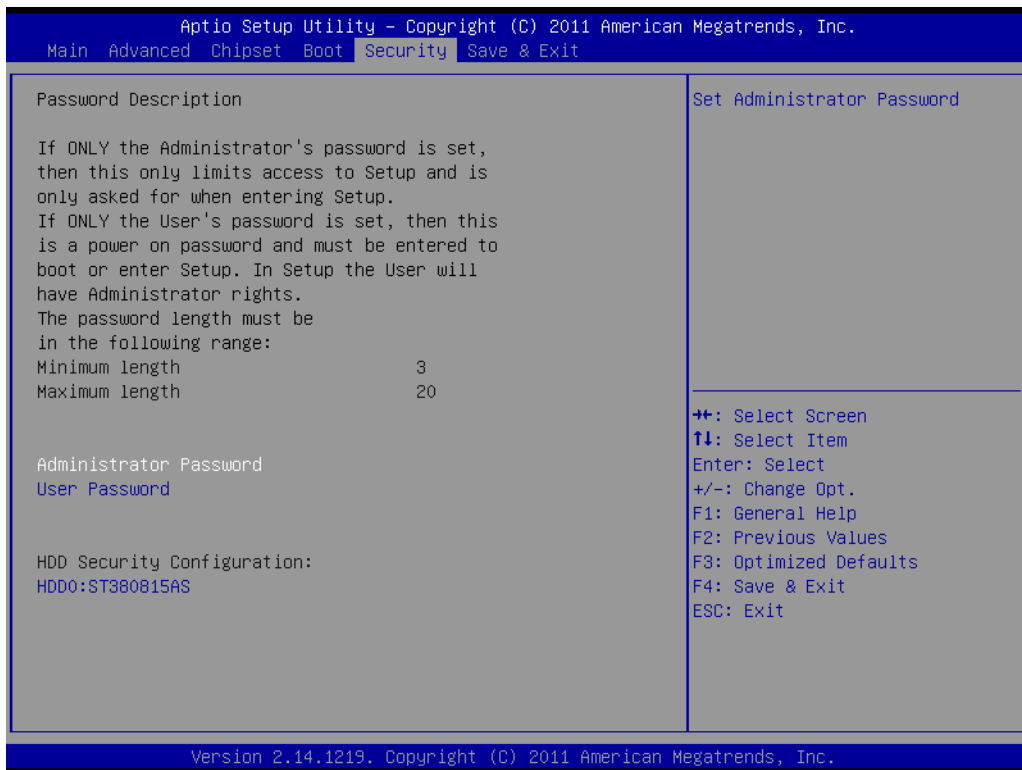

Figure 3.47 Boot Setup Utility

- **Setup Prompt Timeout**  
This item allows users to select the number of seconds to wait for setup activation key.
- **Bootup NumLock State**  
Select the Power-on state for Numlock.
- **Quiet Boot**  
If this option is set to Disabled, the BIOS displays normal POST messages. If Enabled, an OEM Logo is shown instead of POST messages.
- **GateA20 Active**  
Upon request - GA20 can be disable using BIOS services. This option is useful when any RT code is executed above 1MB.
- **Option ROM Message**  
Set display mode for option ROM.
- **Interrupt 19 Capture**  
This item allows option ROMs to trap interrupt 19.
- **1st/2nd/3rd/4th/5th/6th/7th Boot**  
This item allows users to set boot device priority.

### 3.2.5 Security Setup



**Figure 3.48 Password Configuration**

Select Security Setup from the SOM-5892 Setup main BIOS setup menu. All Security Setup options, such as password protection is described in this section. To access the sub menu for the following items, select the item and press <Enter>:

**Change Administrator / User Password:** Select this option and press <ENTER> to access the sub menu, and then type in the password.

## 3.2.6 Save & Exit



Figure 3.49 Save & Exit

- **Save Changes and Exit**

When users have completed system configuration, select this option to save changes, exit BIOS setup menu and reboot the computer if necessary to take effect all system configuration parameters.
- **Discard Changes and Exit**

Select this option to quit Setup without making any permanent changes to the system configuration.
- **Save Changes and Reset**

When users have completed system configuration, select this option to save changes, exit BIOS setup menu and reboot the computer to take effect all system configuration parameters.
- **Discard Changes and Reset**

Select this option to quit Setup without making any permanent changes to the system configuration and reboot the computer.
- **Save Changes**

When users have completed system configuration, select this option to save changes without exit BIOS setup menu.
- **Discard Changes**

Select this option to discard any current changes and load previous system configuration.
- **Restore Defaults**

The SOM-5892 automatically configures all setup items to optimal settings when users select this option. Optimal Defaults are designed for maximum system performance, but may not work best for all computer applications. In particular, do not use the Optimal Defaults if the user's computer is experiencing system configuration problems.



- **Save User Defaults**

When users have completed system configuration, select this option to save changes as user defaults without exit BIOS setup menu.

- **Restore User Defaults**

The users can select this option to restore user defaults.



# Chapter 4

## S/W Introduction & Installation

Sections include:

- S/W Introduction
- Driver Installation
- Advantech iManger

---

## 4.1 S/W Introduction

The mission of Advantech Embedded Software Services is to "Enhance quality of life with Advantech platforms and Microsoft Windows embedded technology." We enable Windows Embedded software products on Advantech platforms to more effectively support the embedded computing community. Customers are freed from the hassle of dealing with multiple vendors (Hardware suppliers, System integrators, Embedded OS distributor) for projects. Our goal is to make Windows Embedded Software solutions easily and widely available to the embedded computing community.

## 4.2 Driver Installation

The Intel Chipset Software Installation (CSI) utility installs the Windows INF files that outline to the operating system how the chipset components will be configured.

### 4.2.1 Windows XP / Windows 7 Driver Setup

To install the drivers please connect to internet and browse the website <http://support.advantech.com.tw> and download the drivers that you want to install and follow Driver Setup instructions to complete the installation.











### 4.2.2 Other OS

To install the drivers for Other OS or Linux, please connect to internet and browse the website <http://support.advantech.com.tw> to download the setup file.

## 4.3 Advantech iManager

Advantech's platforms come equipped with iManager, a micro-controller that provides embedded features for system integrators. Embedded features have been moved from the OS/BIOS level to the board level, to increase reliability and simplify integration.

iManager runs whether the operating system is running or not; it can count the boot times and running hours of the device, monitor device health, and provide an advanced watchdog to handle errors just as they happen. iManager also comes with a secure & encrypted EEPROM for storing important security key or other customer define information. All the embedded functions are configured through API and provide corresponding utilities to demonstrate. These APIs comply with PICMG EAPI (Embedded Application Programmable Interface) specification and unify in the same structures. It makes these embedded features easier to integrate, speed up developing schedule, and provide the customer's software continuity while upgrade hardware. More detail of how to use the APIs and utilities, please refer to Advantech iManager 2.0 Software API User Manual.

Control	Monitor
 <p><b>GPIO</b></p> <p>General Purpose Input/Output is a flexible parallel interface that allows a variety of custom connections. It allows users to monitor the level of signal input or set the output status to switch on/off a device. Our API also provides Programmable GPIO, which allows developers to dynamically set the GPIO input or output status.</p>	 <p><b>Watchdog</b></p> <p>A watchdog timer (WDT) is a device that performs a specific operation after a certain period of time if something goes wrong and the system does not recover on its own. A watchdog timer can be programmed to perform a warm boot (restarting the system) after a certain number of seconds.</p>
 <p><b>SMBus</b></p> <p>SMBus is the System Management Bus defined by Intel® Corporation in 1995. It is used in personal computers and servers for low-speed system management communications. The SMBus API allows a developer to interface a embedded system environment and transfer serial messages using the SMBus protocols, allowing multiple simultaneous device control.</p>	 <p><b>Hardware Monitor</b></p> <p>The Hardware Monitor (HWM) API is a system health supervision API that inspects certain condition indexes, such as fan speed, temperature and voltage.</p>
 <p><b>I2C</b></p> <p>I2C is a bi-directional two wire bus that was developed by Philips for use in their televisions in the 1980s. The I2C API allows a developer to interface with an embedded system environment and transfer serial messages using the I2C protocols, allowing multiple simultaneous device control.</p>	 <p><b>Hardware Control</b></p> <p>The Hardware Control API allows developers to set the PWM (Pulse Width Modulation) value to adjust fan speed or other devices; it can also be used to adjust the LCD brightness.</p>
Display	Power Saving
 <p><b>Brightness Control</b></p> <p>The Brightness Control API allows a developer to interface with an embedded device to easily control brightness.</p>	 <p><b>CPU Speed</b></p> <p>Make use of Intel SpeedStep technology to reduce power consumption. The system will automatically adjust the CPU Speed depending on system loading.</p>
 <p><b>Backlight</b></p> <p>The Backlight API allows a developer to control the backlight (screen) on/off in an embedded device.</p>	 <p><b>System Throttling</b></p> <p>Refers to a series of methods for reducing power consumption in computers by lowering the clock frequency. These APIs allow the user to lower the clock from 67.5% to 12.5%.</p>



# Appendix **A**

## Watchdog Timer

This appendix gives you the information about the watchdog timer programming on the SOM-5892 CPU System on Module.

Sections include:

- Watchdog Timer Programming

---

## A.1 Programming the Watchdog Timer

Trigger Event	Note
IRQ	IRQ7, 9, 11 (default disable) IRQ can be set in BIOS
NMI	N/A
SCI	Power button event
Power Off	Support
H/W Restart	Support
External WDT	N/A

For details, please refer to *iManager & Software API User Manual*.



# Appendix **B**

## Programming GPIO

This Appendix gives the illustration of the General Purpose Input and Output pin setting.

Sections include:

- System I/O ports

---

## B.1 GPIO Register

GPIO Byte Mapping	H/W Pin Name
bit0	GPO0
bit1	GPO1
bit2	GPO2
bit3	GPO3
bit4	GPI0
bit5	GPI1
bit6	GPI2
bit7	GPI3

For details, please refer to *iManager & Software API User Manual*.

# Appendix **C**

## System Assignments

This appendix gives you the information about the system resource allocation on the SOM-5892 CPU System on Module.

Sections include:

- System I/O ports
- DMA Channel Assignments
- Interrupt Assignments
- 1st MB Memory Map

## C.1 System I/O Ports

**Table C.1: System I/O Ports**

Addr.range (Hex)	Device
0000 - 001F	Direct memory access controller
0020 - 0021	Programmable interrupt controller
0022 - 003F	Motherboard resources
0040 - 0043	System timer
0044 - 005F	Motherboard resources
0060 - 0060	Standard 101/102-Key or Microsoft Natural PS/2 Keyboard
0061 - 0061	Motherboard resources
0062 - 0062	Microsoft ACPI-Compliant Embedded Controller
0063 - 0063	Motherboard resources
0064 - 0064	Standard 101/102-Key or Microsoft Natural PS/2 Keyboard
0065 - 0065	Motherboard resources
0066 - 0066	Microsoft ACPI-Compliant Embedded Controller
0067 - 0067	Motherboard resources
0070 - 0077	System CMOS/real time clock
0072 - 007F	Motherboard resources
0080 - 0080	Motherboard resources
0081 - 0091	Direct memory access controller
0090 - 009F	Motherboard resources
00A0 - 00A1	Programmable interrupt controller
00A2 - 00BF	Motherboard resources
00C0 - 00DF	Direct memory access controller
00E0 - 00EF	Motherboard resources
00F0 - 00FF	Numeric data processor
01F0 - 01F7	Primary IDE Channel
01CE-01CF	VGASAVE
0200-020F	Motherboard resources
0274 - 0277	ISAPNP Read Data Port
0279 - 0279	ISAPNP Read Data Port
029C-029D	Motherboard resources
02E8-02EF	VGASAVE
02F8-02FF	Communications Port (COM2)
0378-037F	ECP Printer Port (LPT1)
03B0-03BB	VGASAVE
03C0-03DF	VGASAVE
03F8-03FF	Communications Port (COM1)
0400-0453	Motherboard resources
0454-0457	Motherboard resources
0458-047F	Motherboard resources
04D0-04D1	Programmable interrupt controller
0500-057F	Motherboard resources
0680-069F	Motherboard resources
0778-077F	ECP Printer Port (LPT1)
0A79-0A79	ISAPNP Read Data Port

164E-164F	Motherboard resources
F000-F03F	Video Controller
F040-F05F	SM Bus Controller
F060-F07F	Ethernet Controller
F080-F08F	Standard Dual Channel PCI IDE Controller
F090-F09F	Standard Dual Channel PCI IDE Controller
F0A0-F0A3	Standard Dual Channel PCI IDE Controller
F0B0-F0B7	Standard Dual Channel PCI IDE Controller
F0C0-F0C3	Standard Dual Channel PCI IDE Controller
F0D0-F0D7	Standard Dual Channel PCI IDE Controller
F0E0-F0EF	Standard Dual Channel PCI IDE Controller
F0F0-F0FF	Standard Dual Channel PCI IDE Controller
F100-F103	Standard Dual Channel PCI IDE Controller
F110-F117	Standard Dual Channel PCI IDE Controller
F120-F123	Standard Dual Channel PCI IDE Controller
F130-F137	Standard Dual Channel PCI IDE Controller
FFFF-FFFF	Motherboard resources

## C.2 DMA Channel Assignments

**Table C.2: DMA Channel Assignments**

Channel	Function
3	ECP Printer Port (LPT1)
4	Direct memory access controller

## C.3 Interrupt Assignments

**Table C.3: Interrupt assignments**

Interrupt#	Interrupt source
NMI	Parity error detected
IRQ 0	System timer
IRQ 1	Standard 101/102-Key or Microsoft Natural PS/2 Keyboard
IRQ 3	Communications Port (COM2)
IRQ 4	Communications Port (COM1)
IRQ 8	System CMOS/real time clock
IRQ 9	Microsoft ACPI-Compliant System
IRQ 12	PS/2 Compatible Mouse
IRQ 13	Numeric data processor

## C.4 1st MB Memory Map

**Table C.4: 1st MB memory map**

Addr. range (Hex)	Device
000A0000-000BFFFF	PCI Bus
000D0000-000D3FFF	PCI Bus
000D4000-000D7FFF	PCI Bus
000D8000-000DBFFF	PCI Bus
000DC000-000DFFFF	PCI Bus
000E0000-000E3FFF	PCI Bus
000E4000-000E7FFF	PCI Bus
20000000-201FFFFFFF	System board
40004000-40004FFF	System board
DFA00000-FEAFFFFFFF	PCI Bus
FED00000-FED003FF	High precision event timer
FED10000-FED17FFF	Motherboard resources
FED18000-FED18FFF	Motherboard resources
FED19000-FED19FFF	Motherboard resources
FED1C000-FED1FFFF	Motherboard resources
FED20000-FED3FFFF	Motherboard resources
FFE40000-FED44FFF	System board
FED45000-FED8FFFF	Motherboard resources
FED90000-FED93FFF	Motherboard resources
FEE00000-FEEFFFFFFF	Motherboard resources
FF000000-FFFFFFFF	Intel 82802 Firmware Hub Device



**ADVANTECH**

*Enabling an Intelligent Planet*

**[www.advantech.com](http://www.advantech.com)**

Please verify specifications before quoting. This guide is intended for reference purposes only.

All product specifications are subject to change without notice.

No part of this publication may be reproduced in any form or by any means, electronic, photocopying, recording or otherwise, without prior written permission of the publisher.

All brand and product names are trademarks or registered trademarks of their respective companies.

© Advantech Co., Ltd. 2012